



Sectional Garage Doors

Technical Manual: Issue 01.03.2013



CONTENTS

Contents	Page
Door type / door leaf	3 – 4
Door type / door leaf	4
LTE 40, S-ribbed, Woodgrain	5
LTE 40, M-ribbed, Woodgrain	6
LTE 40, S-panelled, Woodgrain	7
EPU 40, M-ribbed, Woodgrain	8
EPU 40, S-panelled, Woodgrain	9
LPU 40, S-ribbed, Woodgrain	10
LPU 40, M-ribbed, Woodgrain	11
LPU 40, M-ribbed, New Silkgrain, Micrograin, Decograin or Duragrain Decor	12
LPU 40, L-ribbed, Woodgrain	13
LPU 40, L-ribbed, New Silkgrain, Micrograin or Duragrain Decor	14
LPU 40, S-panelled, Woodgrain	15
LPU 40, S-panelled, Decograin or Duragrain Decor	16
Sunrise glazing LTE 40 / EPU 40 / LPU 40	17
Design element LPU 40	18
LPU 40 with wicket door, S, M, L-ribbed, Woodgrain, New Silkgrain, Decograin or Duragrain Decor	19
LPU 40 with wicket door, S, M, L-ribbed, matching exterior view for doors with glazing	20
LPU 40 with wicket door, S-panelled, Woodgrain, Decograin or Duragrain Decor	21
LPU 40 with wicket door, arrangement of the wicket door	22
LTH 40, S, M, L-ribbed, V-panelled	23
LTH 40 with special designs	24
LPU 40, S-ribbed, Woodgrain, fitting in front of the reveal	25
LPU 40, M-ribbed, Woodgrain, New Silkgrain or Micrograin, fitting in front of the reveal	26
LPU 40, L-ribbed, Woodgrain, New Silkgrain or Micrograin, fitting in front of the reveal	27
LPU 40, S-panelled, Woodgrain, fitting in front of the reveal	28
Track application Z	29
Track application N	30
Track application L	31
Track application H	32
Track application N with wicket door	33
Track application L with wicket door	34
Track application BZ	35
Track application BL	36
Track application BL with wicket door	37
Track application Z, fitting in front of the reveal	38
Sideroom	39
Sideroom and lintel fitting with ThermoFrame	40
Sideroom, fitting in front of the reveal	41
Lintel fitting with fascia panels	42
Bottom edge	43
Side doors with corner frames made of aluminium profiles, standard sizes	44 – 45
Side doors with block frames made of aluminium profiles, standard sizes	46 – 47
Side doors with block frames made of aluminium profiles, special sizes	48 – 49
Double-leaf side doors with block frames made of aluminium profiles	50
Timber side doors, standard sizes / special sizes	51

Note:

Duragrain Decor available from autumn 2013.

Door leaf constructions and track applications as well as fitting examples are provided in this manual.

Before fitting a sectional door, the structural opening must be finished and the garage floor must be laid and level.

No part may be reproduced without our prior permission.

All rights reserved.

All dimensions in mm.

Subject to design changes.

Door type	Door leaf
Sectional door LTE 40 – single-skinned steel sections	
<ul style="list-style-type: none"> • S-ribbed Woodgrain • M-ribbed Woodgrain 	<ul style="list-style-type: none"> • Single-skinned door sections, Woodgrain-embossed • Equal-height door sections, horizontally ribbed, in hot-galvanized sheet steel • Surface with polyester-primer coating • Glazings not possible in the two bottom door sections
<ul style="list-style-type: none"> • S-panelled Woodgrain 	<ul style="list-style-type: none"> • Single-skinned door sections, Woodgrain-embossed • Hot galvanized sheet steel door sections of equal height with panelling • Surface with polyester-primer coating • Glazings not possible in the two bottom door sections
Sectional door EPU 40 – double-skinned steel sections	
<ul style="list-style-type: none"> • M-ribbed Woodgrain 	<ul style="list-style-type: none"> • Double-skinned, PU-foamed door sections, 42/20 mm, Woodgrain-embossed exterior, Stucco-textured interior • Equal-height door sections, horizontally ribbed, in hot-galvanized sheet steel • Surface with polyester-primer coating • Glazings not possible in the two bottom door sections
<ul style="list-style-type: none"> • S-panelled Woodgrain 	<ul style="list-style-type: none"> • Double-skinned, PU-foamed door sections, 42/20 mm, Woodgrain-embossed exterior, Stucco-textured interior • Hot galvanized sheet steel door sections of equal height with panelling • Surface with polyester-primer coating • Glazings not possible in the two bottom door sections
Sectional door LPU 40 – double-skinned steel sections	
<ul style="list-style-type: none"> • S-ribbed Woodgrain • M-ribbed Woodgrain, New Silkgrain, Micrograin, Decograin or Duragrain decor • L-ribbed Woodgrain, New Silkgrain, Micrograin or Duragrain decor 	<ul style="list-style-type: none"> • Double-skinned, PU-foamed door sections, Woodgrain, New Silkgrain, Micrograin, or Decograin-embossed exterior, Stucco-textured interior • Hot galvanized sheet steel door sections of equal height with horizontal ribbing or without ribbing • Surface with polyester-primer coating (with Decograin, plastic film coating on the outside) • Glazings not possible in the two bottom door sections
<ul style="list-style-type: none"> • S-panelled Woodgrain, Decograin or Duragrain decor 	<ul style="list-style-type: none"> • Double-skinned, PU-foamed door sections, Woodgrain, Decograin or Duragrain-embossed exterior, Stucco-textured interior • Hot galvanized sheet steel door sections of equal height with panelling • Surface with polyester-primer coating (with Decograin, plastic film coating on the outside) • Glazings not possible in the two bottom door sections
Fitting in front of the reveal <ul style="list-style-type: none"> • S-ribbed Woodgrain • M-ribbed Woodgrain, New Silkgrain or Micrograin • L-ribbed Woodgrain, New Silkgrain or Micrograin 	<ul style="list-style-type: none"> • Double-skinned, PU-foamed door sections, Woodgrain, New Silkgrain, or Micrograin-embossed exterior, Stucco-textured interior • Hot galvanized sheet steel door sections of equal height with horizontal ribbing or without ribbing • Surface with polyester-primer coating • Glazings not possible in the two bottom door sections
Fitting in front of the reveal <ul style="list-style-type: none"> • S-panelled Woodgrain 	<ul style="list-style-type: none"> • Double-skinned, PU-foamed door sections, Woodgrain-embossed exterior, Stucco-textured interior • Hot galvanized sheet steel door sections of equal height with panelling • Surface with polyester-primer coating • Glazings not possible in the two bottom door sections
Sectional door LPU 40 with wicket door – double-skinned steel sections	
<ul style="list-style-type: none"> • S-ribbed Woodgrain • M-ribbed Woodgrain, New Silkgrain, Decograin or Duragrain decor • L-ribbed Woodgrain, New Silkgrain or Duragrain decor 	<ul style="list-style-type: none"> • Double-skinned, PU-foamed door sections, Woodgrain, New Silkgrain, Decograin or Duragrain-embossed exterior, Stucco-textured interior • Hot galvanized sheet steel door sections of equal height with horizontal ribbing or without ribbing • Surface with polyester-primer coating (with Decograin, plastic film coating on the outside) • Glazings not possible in the two bottom door sections • Without door handle set, without inside locking, without single-skinned steel fascia, without design elements, upper door section with lintel seal • We recommend fitting a garage door operator SupraMatic P.

Further details can be obtained in the brochure.

Door type	Door leaf
<ul style="list-style-type: none"> • S-panelled Woodgrain, Decograin or Duragrain decor 	<ul style="list-style-type: none"> • Double-skinned, PU-foamed door sections, Woodgrain, Decograin or Duragrain-embossed exterior, Stucco-textured interior • Hot-galvanized sheet steel door sections of equal height with panelling • Surface with polyester-primer coating • Glazings not possible in the two bottom door sections • Without door handle set, without inside locking, without single-skinned steel fascia, upper door section with lintel seal • We recommend fitting a garage door operator SupraMatic P.

Sectional door LTH 40

<ul style="list-style-type: none"> • S-ribbed, Nordic Pine / Hemlock • M-ribbed, Nordic Pine / Hemlock • L-ribbed, Nordic Pine / Hemlock • V-panelled, Nordic Pine / Hemlock 	<ul style="list-style-type: none"> • Solid timber door sections, S, M, L-ribbed or V-panelled • Door sections of equal height • Pine-impregnated surface protects against blue stain and wood pests • Glazings not possible in the two bottom door sections
--	---

Sectional door LTH 40 with special designs

Nordic Pine / Hemlock	<ul style="list-style-type: none"> • Solid timber sections with different door styles • Door sections of equal height • Pine-impregnated surface protects against blue stain and wood pests • Door styles 403 and 404 with natural stone infill on request
------------------------------	--

Further details can be obtained in the brochure.

Door type	Door leaf
Side doors with corner frames made of aluminium profiles	
Standard sizes	<ul style="list-style-type: none"> • Appearance same as LTE 40 / EPU 40 / LPU 40, leaf frame made of aluminium extrusions, depth 60 mm • PU-foamed steel-section door infill; Woodgrain, New Silkgrain, Decograin or Duragrain-embossed exterior, Stucco-textured interior • Surface with polyester-primer coating (with Decograin, plastic film coating on the outside) • Alignment of sections / ribbing / panelling is only possible with doors of the same height

Side doors with block frames made of aluminium profiles

Standard / special sizes	<ul style="list-style-type: none"> • Appearance same as LTE 40 / EPU 40 / LPU 40, leaf frame and frame made of aluminium extrusions (without thermal breaks), depth 60 mm, double buffer sealing on 3 sides • As standard, plug holes are pre-drilled in the frame according to the fitting arrangement (see reverse side of the order form) • PU-foamed steel-section door infill; Woodgrain, New Silkgrain, Decograin or Duragrain-embossed exterior, Stucco-textured interior • Surface with polyester-primer coating (with Decograin, plastic film coating on the outside) • Alignment of sections / ribbing / panelling is only possible with doors of the same height
---------------------------------	--

Timber side doors

Standard / special sizes	<ul style="list-style-type: none"> • Appearance same as LTH 40 • Solid timber door leaf and frame, Nordic Pine or Hemlock; door leaf depth 42 mm, buffer sealing on 3 sides • Double seal in threshold area • Pine-impregnated surface protects against blue stain and wood pests
---------------------------------	---

Further details can be obtained in the brochures.

Sectional Door LTE 40

Single-skinned steel sections

S-ribbed

Woodgrain

External views

(The illustrations correspond to size 2500 × 2125 mm. Deviations may occur with other sizes.)

Basic model



With aluminium frame

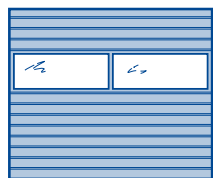

With glazing type D

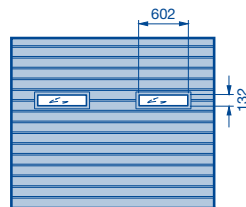

Note:

Different glazing arrangements are not possible!

Size range

Door width in 5 mm increments, door height in grid height. Intermediate heights are not possible.

		A	B	C										
RM	3000	6	500	125										
	2875	6	479	120										
	2750	5	550	138										
	2625	5	525	131										
	2500	5	500	125										
	2375	5	475	119										
	2250	4	562	141										
	2205	4	550	138										
	2125	4	531	133										
	2080	4	520	130										
	2000	4	500	125										
	1955	4	488	122										
	1875	4	468	117										
			Number of infills per door section with glazing											
		2	3	4	5									
		2250	2375	2500	2750	3000	3250	3500	3750	4000	4250	4500	4750	5000
		LZ												

Doors up to 3000 × 2625 mm: with tension spring assembly

A No. of door sections
B Door section height

C Spacing
RM Grid height
LZ Clear frame dimensions (from 2000)

Special equipment

Ventilation

- Ventilation slots in bottom door section, ventilation cross section 65 cm² for one metre door width
- Ventilation slots in bottom seal, ventilation cross section 65 cm² for one metre door width
- Aluminium frame with expanded mesh 58 % ventilation cross section

Glazing options

- Aluminium frame (standard profile NF)
- Glazing type D, 3 mm

Sectional Door LTE 40

Single-skinned steel sections

M-ribbed

Woodgrain

External views

(The illustrations correspond to size 2500 × 2125 mm. Deviations may occur with other sizes.)

Basic model

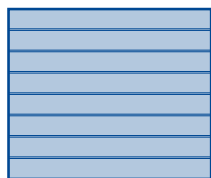

With aluminium frame

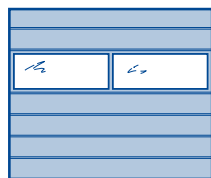

With glazing type D

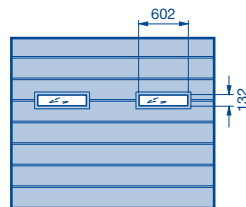

Note:

Different glazing arrangements are not possible!

Size range

Door width in 5 mm increments, door height in grid height. Intermediate heights are not possible.

														A	B	C					
RM	3000														6	500	250				
	2875														6	479	239				
	2750														5	550	275				
	2625														5	525	262				
	2500														5	500	250				
	2375														5	475	237				
	2250														4	562	281				
	2205														4	550	275				
	2125														4	531	265				
	2080														4	520	260				
	2000														4	500	250				
	1955														4	488	244				
	1875														4	468	234				
		2		3															Number of infills per door section with glazing		
		2250	2375	2500	2750	3000	3250	3500	3750	4000	4250	4500	4750	5000							
		LZ																			

Doors up to 3000 × 2625 mm: with tension spring assembly

A No. of door sections
B Door section height

C Spacing
RM Grid height
LZ Clear frame dimensions (from 2000)

Special equipment

Ventilation

- Ventilation slots in bottom door section
ventilation cross section 65 cm² for one metre door width
- Ventilation slots in bottom seal,
ventilation cross section 65 cm² for one metre door width
- Aluminium frame with expanded mesh
58 % ventilation cross section

Glazing options

- Aluminium frame (standard profile NF)
- Glazing type D, 3 mm

Sectional Door LTE 40

Single-skinned steel sections

S-panelled

Woodgrain

External views

(The illustrations correspond to size 2500 × 2125 mm. Deviations may occur with other sizes.)

Basic model

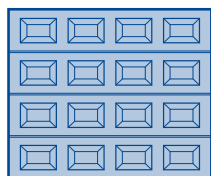

Style S0

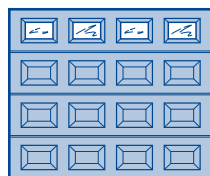

Style S1 with decorative rail (rhombus)

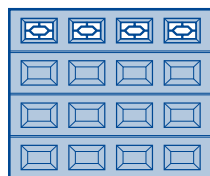

Style S2 with decorative rail (cross)

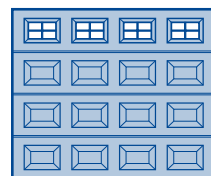

Style S10

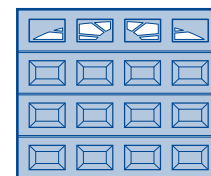

Size range

Door width in 5 mm increments, door height only in one of the grid heights shown. Intermediate heights are not possible.

														A	B		
RM	3000														6	500	
	2875														6	479	
	2750														5	550	
	2625														5	525	
	2500														5	500	
	2375														5	475	
	2250														4	562	
	2205														4	550	
	2125														4	531	
	2080														4	520	
	2000														4	500	
	1955														4	488	
	1875														4	468	
			3 → 2070	4 → 2740			5									Number of panels per door section	
			2250	2375	2500	2750	3000	3250	3500	3750	4000	4250	4500	4750	5000		
		LZ															

Doors up to 3000 × 2625 mm: with tension spring assembly

A No. of door sections
B Door section height

RM Grid height
LZ Clear frame dimensions (from 2000)
→ Up to width

Special equipment

Ventilation

- Ventilation slots in bottom door section, ventilation cross section 65 cm² for one metre door width
- Ventilation slots in bottom seal, ventilation cross section 65 cm² for one metre door width

Glazing options – Panel glazing

- Clear or crystal structure panes, 3 mm
- Designs S0, S1, S2
 - Designs S10, S20 (see page 17)

Sectional Door EPU 40

Double-skinned steel sections

M-ribbed

Woodgrain

External views

(The illustrations correspond to size 2500 x 2125 mm. Deviations may occur with other sizes.)

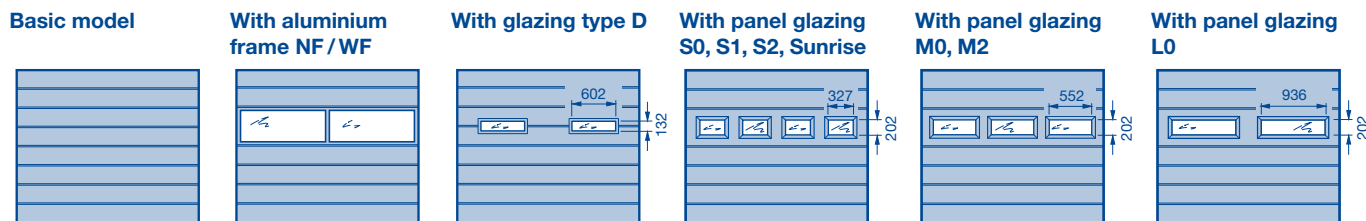

Size range

Door width in 5 mm increments, door height in grid height. Intermediate heights are possible.

												A	B	C
RM	3000											6	500	250
	2875											6	479	239
	2750											5	550	275
	2625											5	525	262
	2500											5	500	250
	2375											5	475	237
	2250											4	562	281
	2205											4	550	275
	2125											4	531	265
	2080											4	520	260
	2000											4	500	250
	1955											4	488	244
	1875											4	468	234
		4		6			8			10		No. of ventilation grilles with 40 cm ² ventilation cross section each		
		2		3			4			5		No. of glazings – aluminium frame and type D		
	3 → 2125	4		5			6			7		8		No. of glazings – type S
	2 → 2240	3 → 2970			4 → 3690			5 → 4420			6		No. of glazings – type M	
		2 → 3400				3 → 4490				4		No. of glazings – type L		
		2250	2375	2500	2750	3000	3250	3500	3750	4000	4250	4500	4750	5000
		LZ												

- Doors up to 3000 x 2625 mm: with tension spring assembly
- A** No. of door sections
- B** Door section height
- C** Spacing
- RM** Grid height
- LZ** Clear frame dimensions (from 2000)
- Up to width

Special equipment

Ventilation

- Ventilation slots in bottom seal, ventilation cross section 65 cm² for one metre door width
- Ventilation grille, ventilation cross section 40 cm² each
- Aluminium frame with expanded mesh 58 % ventilation cross section

Glazing options

- Aluminium frame (standard profile NF or thermal break profile WF)
- Glazing type D, 16 mm
- Panel glazing type S, 22 mm (see page 17)

Sectional Door EPU 40

Double-skinned steel sections

S-panelled

Woodgrain

External views

(The illustrations correspond to size 2500 × 2125 mm. Deviations may occur with other sizes.)

Basic model

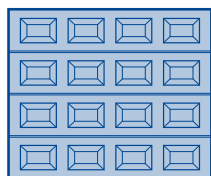

Style S0

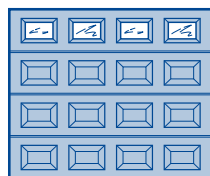

Style S1 with decorative rail (rhombus)

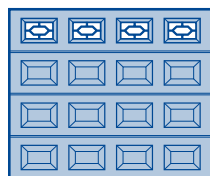

Style S2 with decorative rail (cross)

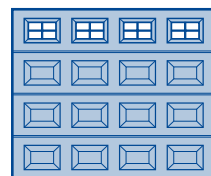

Style S10

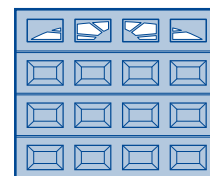

Size range

Door width in 5 mm increments, door height in grid height. Intermediate heights are not possible.

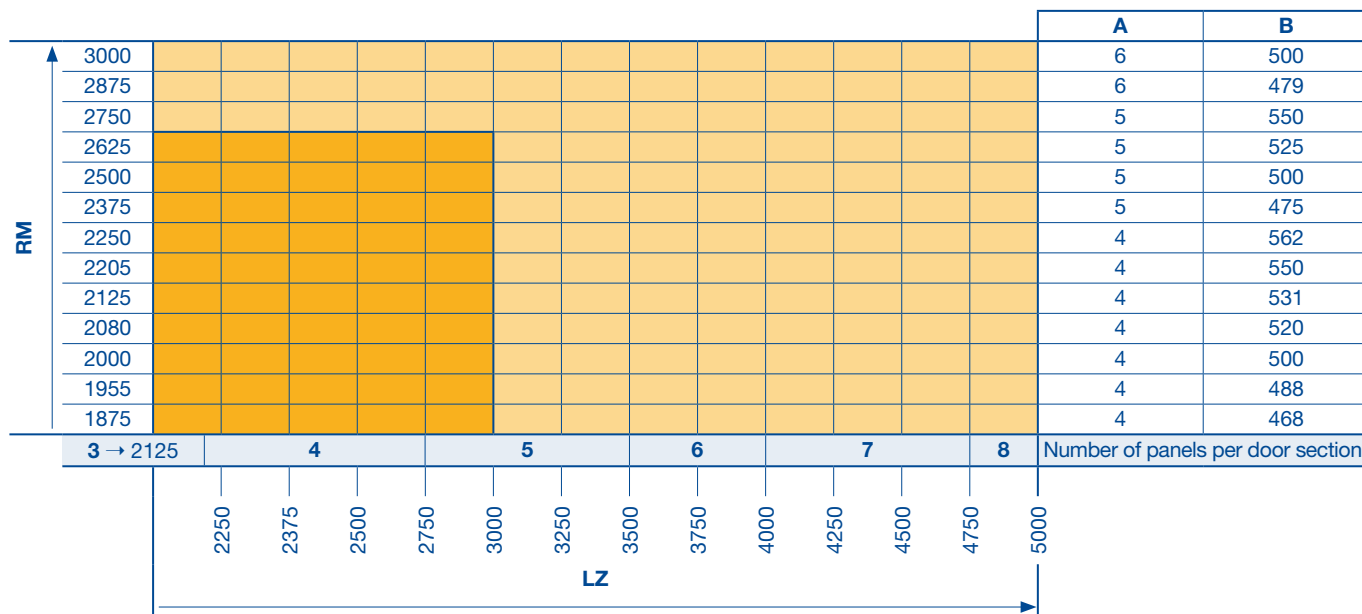

Doors up to 3000 × 2625 mm: with tension spring assembly

A No. of door sections
B Door section height

RM Grid height
LZ Clear frame dimensions (from 2000)
→ Up to width

Special equipment

Ventilation

- Ventilation slots in bottom seal, ventilation cross section 65 cm² for one metre door width

Glazing options – Panel glazing

Clear or crystal structure double panes, 16 mm

- Styles S0, S1, S2
- Styles S10, S20, S30, S40, S50, S60 (see page 17)

Sectional Door LPU 40

Double-skinned steel sections

S-ribbed

Woodgrain

External views

(The illustrations correspond to size 2500 x 2125 mm. Deviations may occur with other sizes.)

Basic model

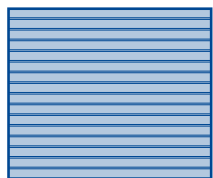

With aluminium frame NF / WF

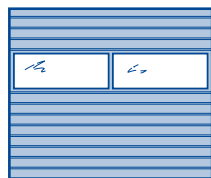

With glazing type D

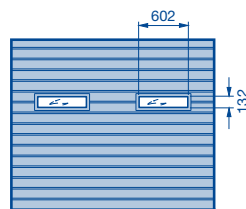

Size range

Door width in 5 mm increments up to LZ = 5500 mm, door height in grid height. Intermediate heights are possible.

RM						A	B	C									
	3000						6	500	125								
2875						6	479	120									
2750						5	550	138									
2625						5	525	131									
2500						5	500	125									
2375						5	475	119									
2250						4	562	141									
2205						4	550	138									
2125						4	531	133									
2080						4	520	130									
2000						4	500	125									
1955						4	488	122									
1875						4	468	117									
		4	6	8	10	12	No. of ventilation grilles with 40 cm ² ventilation cross section each										
		2	3	4	5	6	Number of infills per door section with glazing										
		2250	2375	2500	2750	3000	3250	3500	3750	4000	4250	4500	4750	5000	5250	5500	6000
		LZ															

- Doors up to 3000 x 2625 mm: with tension spring assembly
- A** No. of door sections
- B** Door section height
- C** Spacing
- RM** Grid height
- LZ** Clear frame dimensions (from 2000)

Special equipment

Ventilation

- Ventilation slots in bottom seal, ventilation cross section 65 cm² for one metre door width
- Ventilation grille, ventilation cross section 40 cm² each
- Aluminium frame with expanded mesh 58 % ventilation cross section

Glazing options

- Aluminium frame (standard profile NF or thermal break profile WF)
- Glazing type D, 16 mm

Sectional Door LPU 40

Double-skinned steel sections

M-ribbed

Woodgrain

External views

(The illustrations correspond to size 2500 x 2125 mm. Deviations may occur with other sizes.)

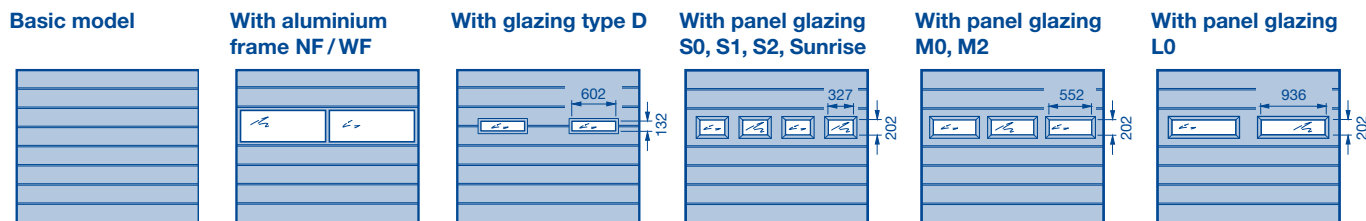

Size range

Door width in 5 mm increments up to LZ = 5500 mm, door height in grid height. Intermediate heights are possible.

RM													A	B	C		
	3000													6	500	250	
2875													6	479	239		
2750													5	550	275		
2625													5	525	262		
2500													5	500	250		
2375													5	475	237		
2250													4	562	281		
2205													4	550	275		
2125													4	531	265		
2080													4	520	260		
2000													4	500	250		
1955													4	488	244		
1875													4	468	234		
		4		6		8		10		12	No. of ventilation grilles with 40 cm ² ventilation cross section each						
		2		3		4		5		6	No. of glazings – aluminium frame and type D						
	3 → 2125		4		5		6		7		8	9	No. of glazings – type S				
	2 → 2240		3 → 2970		4 → 3690		5 → 4420		6 → 5140		7	8	No. of glazings – type M				
			2 → 3400		3 → 4490		4		5	No. of glazings – type L							
		2250	2375	2500	2750	3000	3250	3500	3750	4000	4250	4500	4750	5000	5250	5500	6000
		LZ															

- Doors up to 3000 x 2625 mm: with tension spring assembly
- A** No. of door sections
- B** Door section height
- C** Spacing
- RM** Grid height
- LZ** Clear frame dimensions (from 2000)
- Up to width

Special equipment

Ventilation

- Ventilation slots in bottom seal, ventilation cross section 65 cm² for one metre door width
- Ventilation grille, ventilation cross section 40 cm² each
- Aluminium frame with expanded mesh 58 % ventilation cross section

Glazing options

- Aluminium frame (standard profile NF or thermal break profile WF)
- Glazing type D, 16 mm
- Panel glazing type S, 22 mm (see page 17)

Sectional Door LPU 40

Double-skinned steel sections

M-ribbed

New Silkgrain, Micrograin, Decograin or Duragrain Decor

External views

(The illustrations correspond to size 2500 x 2125 mm. Deviations may occur with other sizes.)

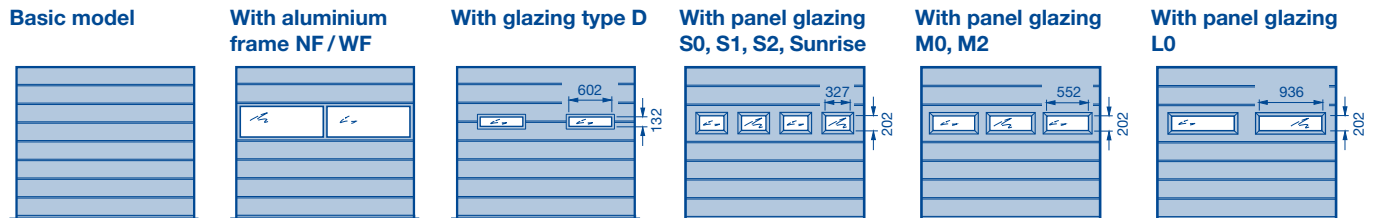

Size range

Door width in 5 mm increments up to LZ = 5500 mm, door height in grid height. Intermediate heights are possible.

RM													A	B	C								
	3000													6	500	250							
2875																							
2750													5	550	275								
2625																							
2500													5	500	250								
2375													5	475	237								
2250													4	562	281								
2205													4	550	275								
2125													4	531	265								
2080													4	520	260								
2000													4	500	250								
1955													4	488	244								
1875													4	468	234								
	4				6				8				10				12				No. of ventilation grilles with 40 cm ² ventilation cross section each		
	2		3		4		5		6		7		8		9		No. of ventilations – aluminium frame and type D						
	3 → 2125		4		5		6		7		8		9		No. of ventilations – type S								
	2 → 2240		3 → 2970			4 → 3690			5 → 4420			6 → 5140			7		8			No. of ventilations – type M			
	2 → 3400						3 → 4490						4						5		No. of ventilations – type L		
	2250	2375	2500	2750	3000	3250	3500	3750	4000	4250	4500	4750	5000	5250	5500	6000	LZ						

- Doors up to 3000 x 2625 mm: with tension spring assembly
- A** No. of door sections
- B** Door section height
- C** Spacing
- RM** Grid height
- LZ** Clear frame dimensions (from 2000)
- Up to width

Special equipment

Ventilation

- Ventilation slots in bottom seal, ventilation cross section 65 cm² for one metre door width
- Ventilation grille, ventilation cross section 40 cm² each
- Aluminium frame with expanded mesh 58 % ventilation cross section

Glazing options

- Aluminium frame (standard profile NF or thermal break profile WF)
- Glazing type D, 16 mm
- Panel glazing type S, 22 mm (see page 17)

Sectional Door LPU 40

Double-skinned steel sections

L-ribbed

Woodgrain

External views

(The illustrations correspond to size 2500 × 2125 mm. Deviations may occur with other sizes.)

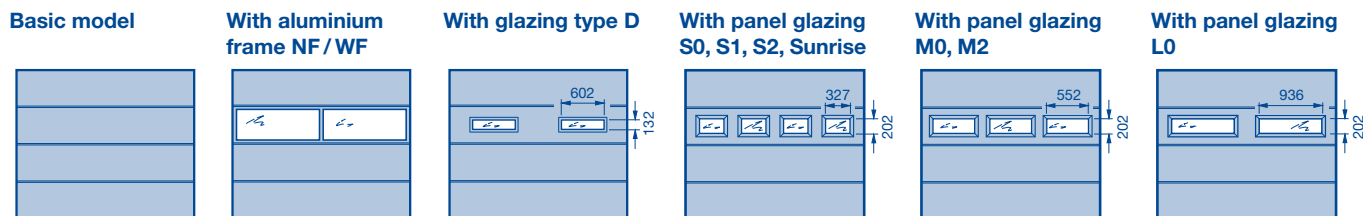

Size range

Door width in 5 mm increments up to LZ = 5500 mm, door height in grid height. Intermediate heights are possible.

RM													A	B			
	3000													6	500		
2875													6	479			
2750													5	550			
2625													5	525			
2500													5	500			
2375													5	475			
2250													4	562			
2205													4	550			
2125													4	531			
2080													4	520			
2000													4	500			
1955													4	488			
1875													4	468			
		4		6		8		10		12	No. of ventilation grilles with 40 cm ² ventilation cross section each						
		2		3		4		5		6	No. of glazings – aluminium frame and type D						
	3 → 2125		4		5		6		7		8	9	No. of glazings – type S				
	2 → 2240		3 → 2970		4 → 3690		5 → 4420		6 → 5140		7	8	No. of glazings – type M				
			2 → 3400		3 → 4490		4		5		5	No. of glazings – type L					
		2250	2375	2500	2750	3000	3250	3500	3750	4000	4250	4500	4750	5000	5250	5500	6000
		LZ															

- Doors up to 3000 × 2625 mm: with tension spring assembly
- A** No. of door sections
- B** Door section height
- RM** Grid height
- LZ** Clear frame dimensions (from 2000)
- Up to width

Special equipment

Ventilation

- Ventilation slots in bottom seal, ventilation cross section 65 cm² for one metre door width
- Ventilation grille, ventilation cross section 40 cm² each
- Aluminium frame with expanded mesh 58 % ventilation cross section

Glazing options

- Aluminium frame (standard profile NF or thermal break profile WF)
- Glazing type D, 16 mm
- Panel glazing type S, 22 mm (see page 17)

Sectional Door LPU 40

Double-skinned steel sections

L-ribbed

New Silkgrain, Micrograin or Duragrain Decor

External views

(The illustrations correspond to size 2500 × 2125 mm. Deviations may occur with other sizes.)

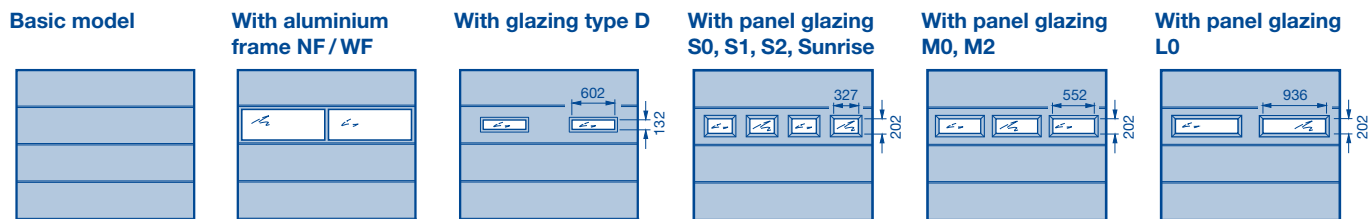

Size range

Door width in 5 mm increments up to LZ = 5500 mm, door height in grid height. Intermediate heights are possible.

														A	B							
RM	3000													6	500							
	2875																					
	2750													5	550							
	2625																					
	2500													5	500							
	2375													5	475							
	2250													4	562							
	2205													4	550							
	2125													4	531							
	2080													4	520							
	2000													4	500							
	1955													4	488							
	1875													4	468							
	4				6				8				10				12				No. of ventilation grilles with 40 cm ² ventilation cross section each	
	2		3		4		5		6		7		8		9		6		No. of glazings – aluminium frame and type D			
	3 → 2125		4		5		6		7		8		9		6		9		No. of glazings – type S			
	2 → 2240		3 → 2970		4 → 3690		5 → 4420		6 → 5140		7		8		8		8		No. of glazings – type M			
	2 → 3400				3 → 4490				4				5				5		No. of glazings – type L			
	2250	2375	2500	2750	3000	3250	3500	3750	4000	4250	4500	4750	5000	5250	5500	6000	LZ					

- Doors up to 3000 × 2625 mm: with tension spring assembly
- A** No. of door sections
- B** Door section height
- RM** Grid height
- LZ** Clear frame dimensions (from 2000)
- Up to width

Special equipment

Ventilation

- Ventilation slots in bottom seal, ventilation cross section 65 cm² for one metre door width
- Ventilation grille, ventilation cross section 40 cm² each
- Aluminium frame with expanded mesh, 58 % ventilation cross section

Glazing options

- Aluminium frame (standard profile NF or thermal break profile WF)
- Glazing type D, 16 mm
- Panel glazing type S, 22 mm (see page 17)

Sectional Door LPU 40

Double-skinned steel sections

S-panelled

Woodgrain

External views

(The illustrations correspond to size 2500 × 2125 mm. Deviations may occur with other sizes.)

Basic model

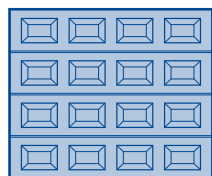

Style S0

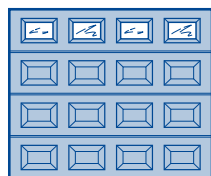

Style S1 with decorative rail (rhombus)

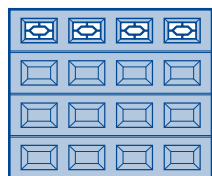

Style S2 with decorative rail (cross)

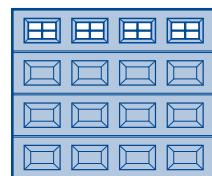

Style S10

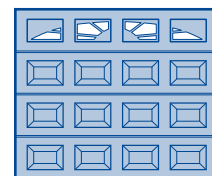

Size range

Door width in 5 mm increments, door height in grid height. Intermediate heights are not possible.

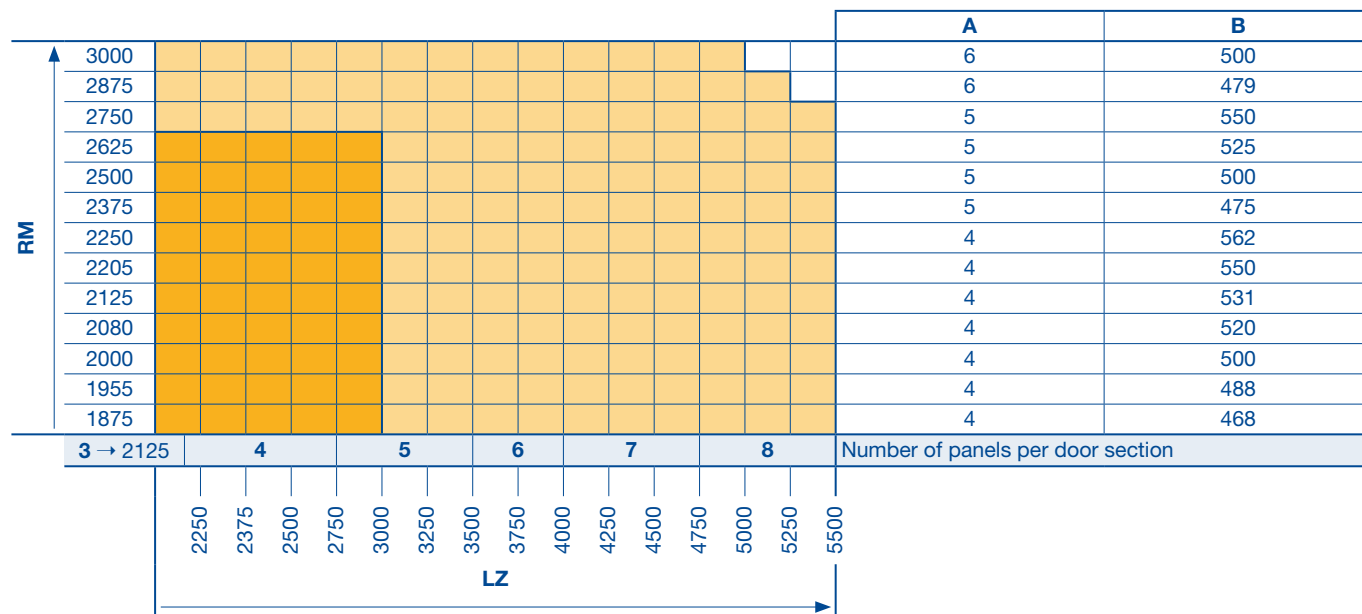

Doors up to 3000 × 2625 mm: with tension spring assembly

A No. of door sections
B Door section height

RM Grid height
LZ Clear frame dimensions (from 2000)
→ Up to width

Special equipment

Ventilation

- Ventilation slots in bottom seal, ventilation cross section 65 cm² for one metre door width

Glazing options – Panel glazing

Clear or crystal structure double panes, 16 mm

- Styles S0, S1, S2
- Styles S10, S20, S30, S40, S50, S60 (see page 17)

Sectional Door LPU 40

Double-skinned steel sections

S-panelled

Decograin or Duragrain Decor

External views

(The illustrations correspond to size 2500 × 2125 mm. Deviations may occur with other sizes.)

Basic model

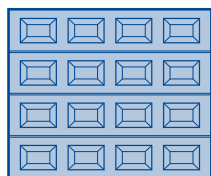

Style S0

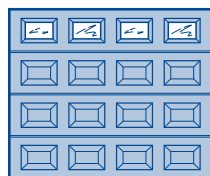

Style S1 with decorative rail (rhombus)

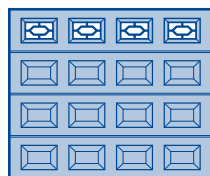

Style S2 with decorative rail (cross)

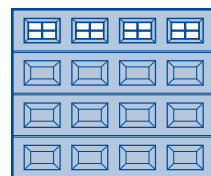

Style S10

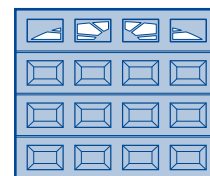

Size range

Door width in 5 mm increments, door height in grid height. Intermediate heights are not possible.

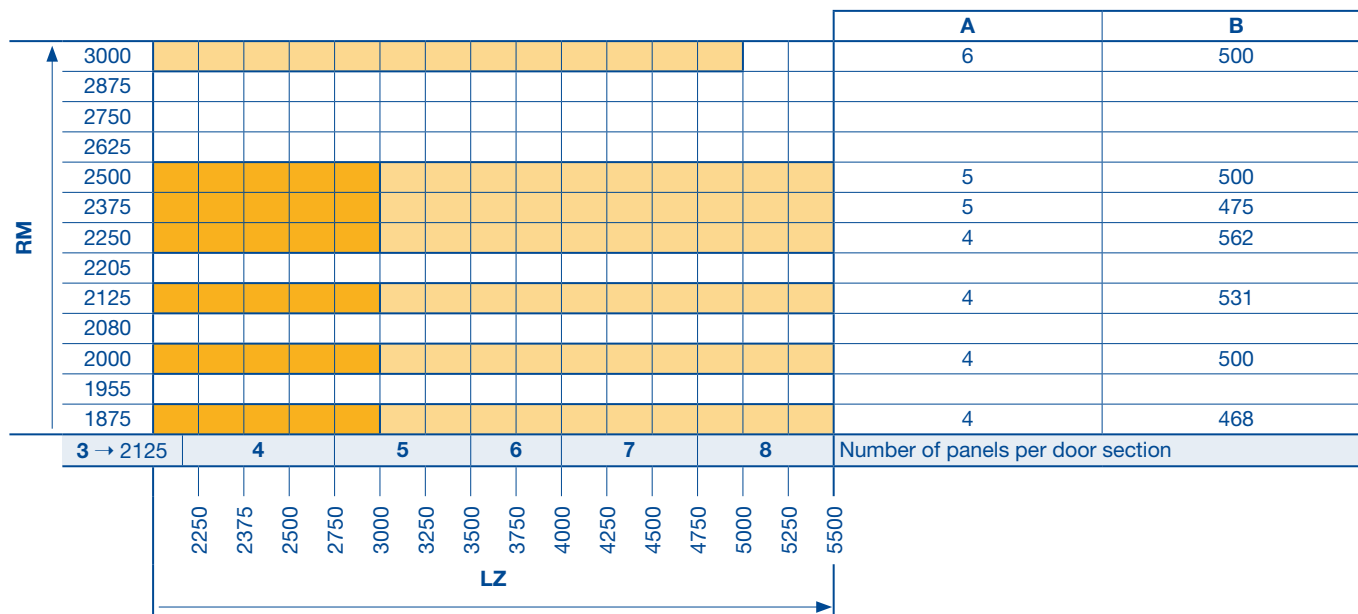

Doors up to 3000 × 2625 mm: with tension spring assembly

A No. of door sections
B Door section height

RM Grid height
LZ Clear frame dimensions (from 2000)
→ Up to width

Special equipment

Ventilation

- Ventilation slots in bottom seal, ventilation cross section 65 cm² for one metre door width

Glazing options – Panel glazing

Clear or crystal structure double panes, 16 mm

- Styles S0, S1, S2
- Styles S10, S20, S30, S40, S50, S60 (see page 17)

Sunrise Glazing

For sectional doors

LTE 40 / EPU 40 / LPU 40

External views

Sunrise glazing for sectional doors LTE / EPU / LPU 40 for standard and special sizes

Glazing options for S-panelled type (not possible for doors with 3 panels for each section)

Style S10

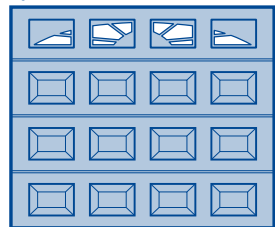

Style S20

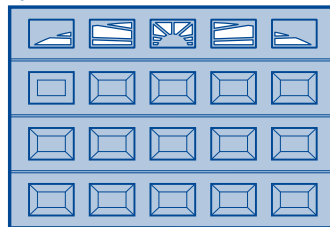

Style S30

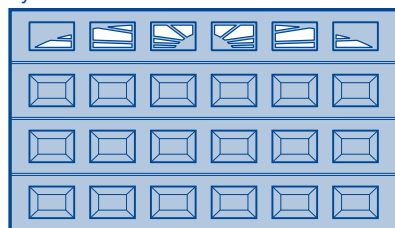

Style S40

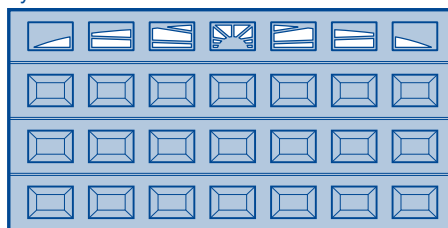

Style S50

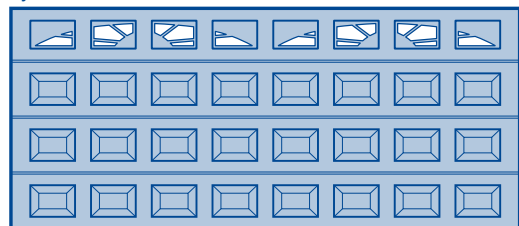

Style S60

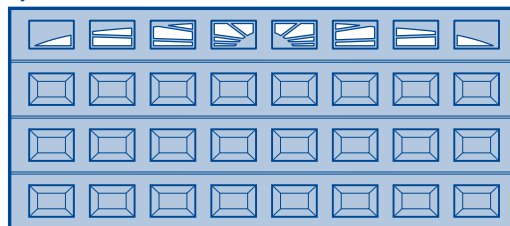

Design Element

For sectional garage doors¹⁾ and side doors

LPU 40, L-ribbed

New Silkgrain

Door view

Design arrangements (external views correspond to door size 2500 x 2125 mm)



Style 450 with stainless steel plinth profile, with square perforation (2-part over 3000 mm width)



Style 451, stainless steel frame optional with stainless steel plinth profile as in style 450³⁾
Style 461, stainless steel frame and synthetic double pane²⁾ optional with stainless steel plinth profile as in style 450³⁾



Style 452, stainless steel frame with infill optional with stainless steel plinth profile as in style 450³⁾
Style 462, stainless steel frame with infill and synthetic double pane²⁾ optional with stainless steel plinth profile as in style 450³⁾



Style 454, large stainless steel square, optional with stainless steel plinth profile as in style 450



Style 456, small stainless steel squares, optional with stainless steel plinth profile as in style 450³⁾ 2 squares only in the bottom section with plinth profile

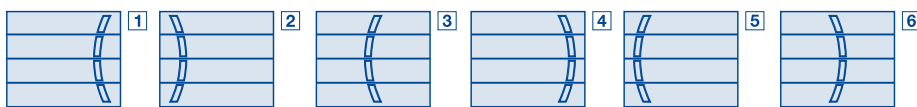

Style 457, curved stainless steel frame

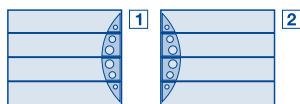

Style 458, stainless steel hole arc

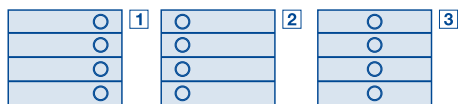

Style 459, with stainless steel ring
Style 469, with stainless steel ring and synthetic double pane²⁾.

Side door view

Design arrangements (External views correspond to door size 1000 x 2125 mm, other door sizes may have a different design)

Style 450

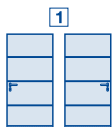

Style 451, 461²⁾

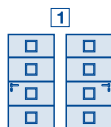

Style 452, 462²⁾

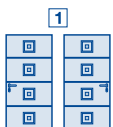

Style 454

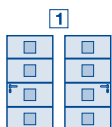

Style 456

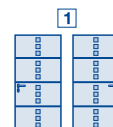

Style 457

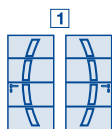

2

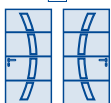

Style 458

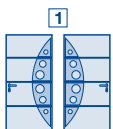

Style 459, 469²⁾

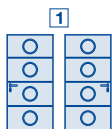

Styles 451, 452, 454, 456, 459, 461, 462 and 469 optional with stainless steel plinth profile as in style 450 (only on door in door heights RM 2125 and 2250 mm)

1) Except doors with wicket doors

2) Glazing with synthetic double pane clear (DS) or crystal structure (DK), 41 mm, 160 x 160 mm clear view

3) Only for RM height 2125 and 2250 mm

Sectional Door LPU 40 with Wicket Door

Double-skinned steel sections

S-ribbed, M-ribbed, L-ribbed

Woodgrain, New Silkgrain, Decograin or Duragrain decor

External views

(The illustrations correspond to door height 2125 mm. Deviations may occur with other heights. Due to the low threshold height, the ground in front of the garage must be level or sloped to guarantee smooth opening of the wicket door (opening outwards) – see page 43.)

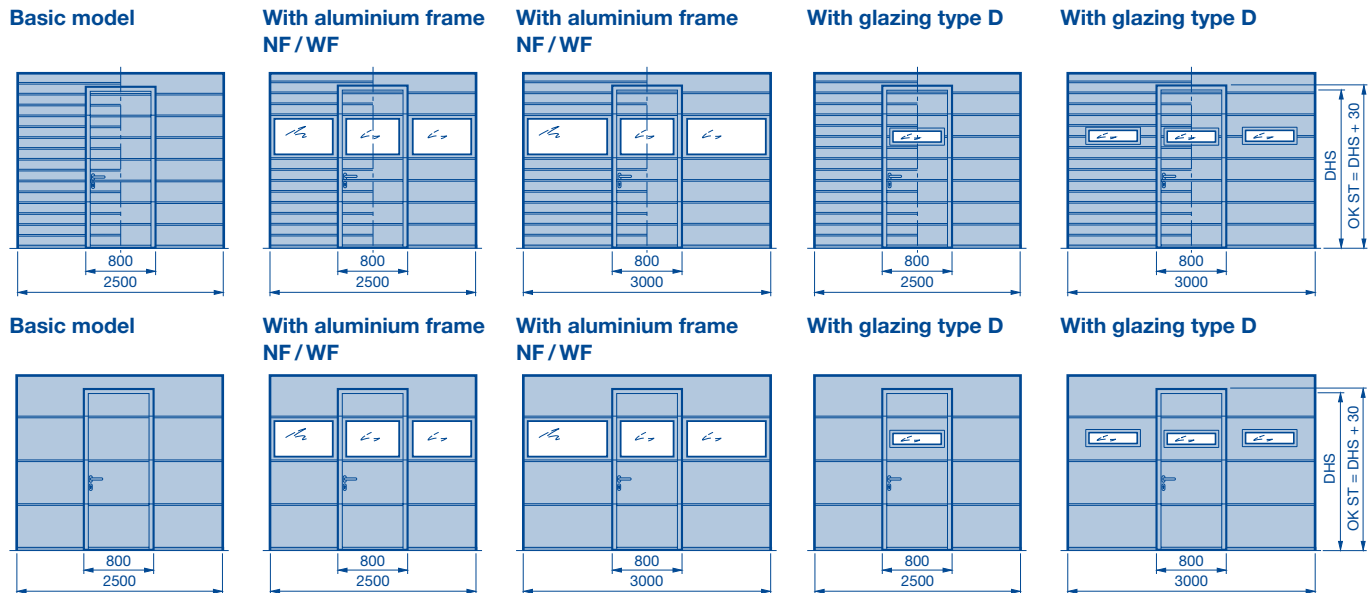

Wicket doors

The wicket doors are always in four parts and in the S-ribbed version, only with even spacing of the ribs. The clear passage width of the wicket door is 800 mm and the threshold height starts at 5 mm and increases to 10 mm. Beyond their standard arrangement, wicket doors **without** glazing can be offset to a fixed edge distance of 500 mm. No design elements possible.

Size range

Door width in 5 mm increments. Door heights in one of the grid heights. Intermediate heights from 5 door sections on request. See track applications for the ceiling height and clear passage (pages 33 – 34). **Please observe the size ranges of the door types.**

		A	B	C	D	DRH	
RM	3000	6	500	1955	1955	831	
	2875	6	479	1871	1871	799	
	2750	5	550	2155	2155	906	
	2625	5	525	2055	2055	868	
	2500	5	500	1955	1955	831	
	2375	5	475	1855	1855	793	
	2250	4	562	2123	2203	924	
	2205	4	550	2075	2155	906	
	2125	4	531	1999	2079	877	
	2080	4	520	1955	2035	861	
	2000	4	500	1875	1955	831	
	1955	4	488	1827	1907	813	
	1875	4	468	1747	1827	782	
	3 → 2500		5 → 3500		7 → 4000		No. of ventilation grilles with 40 cm ² ventilation cross section each
3		4				No. of infills in aluminium frame per door section	
1 → 2500		3 → 3500		4 → 4000		No. of type D, M glazings per door section	
1 → 2370	3 → 3500		4 → 4000		No. of type S glazings per door section		
2375		2500		2750		3000	
		3250		3500		3750	
						4000	
						LZ	

- A** No. of door sections
- B** Door section height
- C** Clear passage height of wicket door (DHS)
- D** Clear passage height of the wicket door (DHS) with top glazing type D, S, M
- DRH** Lever height
- RM** Grid height
- LZ** Clear frame dimensions (from 2250)
- OK ST** Top edge of wicket door
- Up to width
- Grid heights RM not possible with Decograin and Duragrain

Note:
From LZ ≥ 3510 mm the wicket door is set off-centre!
Sectional door with wicket door only possible with track application N or L!

Note:
For doors up to RM 2250 and with top glazing type D, S, M, the distance from FFL to the bottom edge of the lintel must be equal to or greater than the ordering size (RM).

Ventilation via S/M/L-ribbed panels

- Ventilation grille, ventilation cross section 40 cm² each arrangement



- Aluminium frame with expanded mesh, 58 % ventilation cross section

Glazing options

- Aluminium frame (standard profile NF or thermal break profile WF)
- Glazing type D, 16 mm
- Panel glazing type S, 22 mm
- With wicket door multiple-point locking, glazings above the wicket door possible (from 5th section from the bottom)
- With integrated overhead door closer, glazing type S, M, NF & WF not possible, possible in the 4th wicket door section (only left and right next to the ST, except for ST arrangements "a" & "b")

Sectional Door LPU 40 with Wicket Door

Double-skinned steel sections

S-ribbed, M-ribbed, L-ribbed

Woodgrain, New Silkgrain, Decograin or Duragrain decor

Matching external view for doors with glazing

External views External views

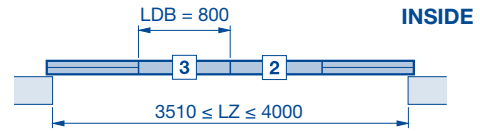
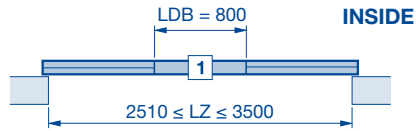

Glazing type D



Glazing type D



Glazing type S



Glazing type S



Glazing type M



Glazing type M



Aluminium frame NF / WF

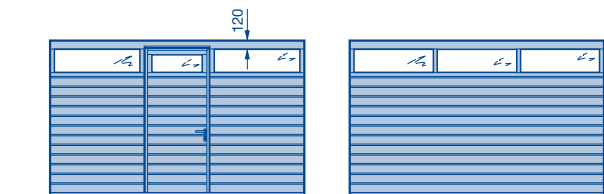

Aluminium frame NF / WF



The illustrations correspond to door height 2125 mm and arrangement 3.

Sectional Door LPU 40 with Wicket Door

Double-skinned steel sections

S-panelled

Woodgrain, Decograin or Duragrain decor

External views

(The illustrations correspond to size 2500 × 2125 mm. Deviations may occur with other sizes. Due to the low threshold height, the ground in front of the garage must be level or sloped to guarantee smooth opening of the wicket door (opening outwards) – see page 43.

Basic model

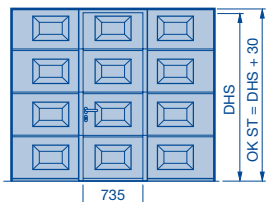

Style S0

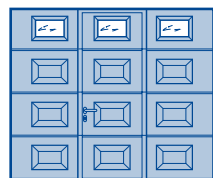

Style S1 with decorative rail (rhombus)

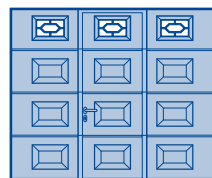

Style S2 with decorative rail (cross)

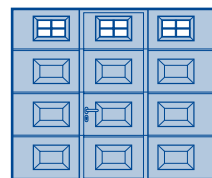

Wicket doors

The wicket doors are always in four parts. The clear passage width of the wicket door is 735 mm and the threshold height starts at 5 mm and increases to 10 mm.

Size range

Door width in 5 mm increments, door height only in grid height. Intermediate heights are not possible. See track applications for the ceiling height and clear passage (pages 33–34).

		A	B	C	DRH				
RM	3000	6	500	1955	831				
	2875	6	479	1871	799				
	2750	5	550	2155	906				
	2625	5	525	2055	868				
	2500	5	500	1955	831				
	2375	5	475	1855	793				
	2250	4	562	2203	924				
	2205	4	550	2155	906				
	2125	4	531	2079	877				
	2080	4	520	2035	861				
	2000	4	500	1955	831				
	1955	4	488	1907	813				
			3	4	5	Numbers of panels / panel glazings per door section			
		2500	2750	3000	3250	3500	3750	4000	LZ

A	No. of door sections
B	Door section height
C	Clear passage height of wicket door (DHS)
DRH	Lever height
RM	Grid height
LZ	Clear frame dimensions (from 2250)
OK ST	Top edge of wicket door
→	Up to width
●	Grid heights RM not possible with Decograin and Duragrain

Note:

With 4 panels, the wicket door is set off-centre!
Sectional door with wicket door only possible with track application N or L!

Note:

For doors up to RM 2250, the distance from FFL to the bottom edge of the lintel must be equal to or greater than the ordering size (RM).

Special equipment

Glazing options – Panel glazing

Clear or crystal structure double panes, 16 mm

- Design S0
- Design S1
- Design S2
- Designs S10, S20 (see page 17)
- With wicket door multiple-point locking, glazings above the wicket door possible (from 5th section from the bottom)
- With integrated overhead door closer, glazing type S, M, NF & WF not possible, possible in the 4th wicket door section (only left and right next to the ST)

Sectional Door LPU 40 with Wicket Door

Arrangement of the wicket door

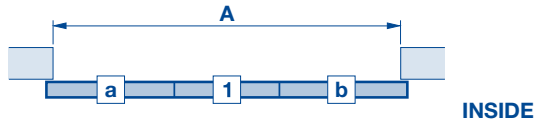

Note:

Arrangement “a” and “b” only if S, M and L-ribbed without glazing. 500 mm fixed distance from the edge.

Note:

Wicket door only opening outwards.

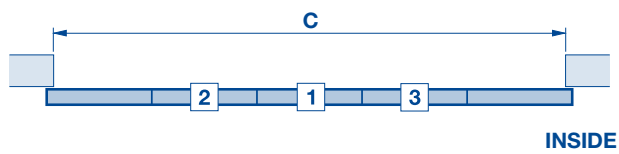
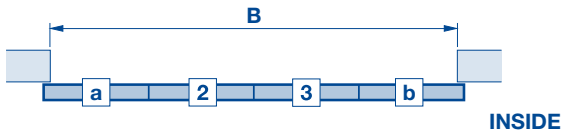

	A	B	C
Sectional door S, M or L-ribbed	2250 – 3500	3510 – 4000	–
Sectional door, S-panelled	2250 – 2500	2505 – 3250	3255 – 4000

Sectional Door LTH 40

S-ribbed, M-ribbed, L-ribbed, V-panelled

Nordic Pine / Hemlock

External views

(The illustrations correspond to size 2500 × 2125 mm. Deviations may occur with other sizes.)

Basic model S-ribbed

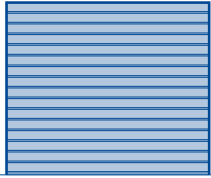

Basic model M-ribbed



Basic model L-ribbed

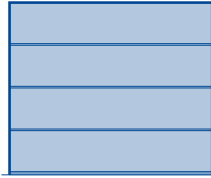

Basic model V-panelled

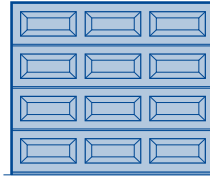

With glazing V0

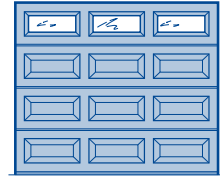

Size range

Door width in 10 mm increments.

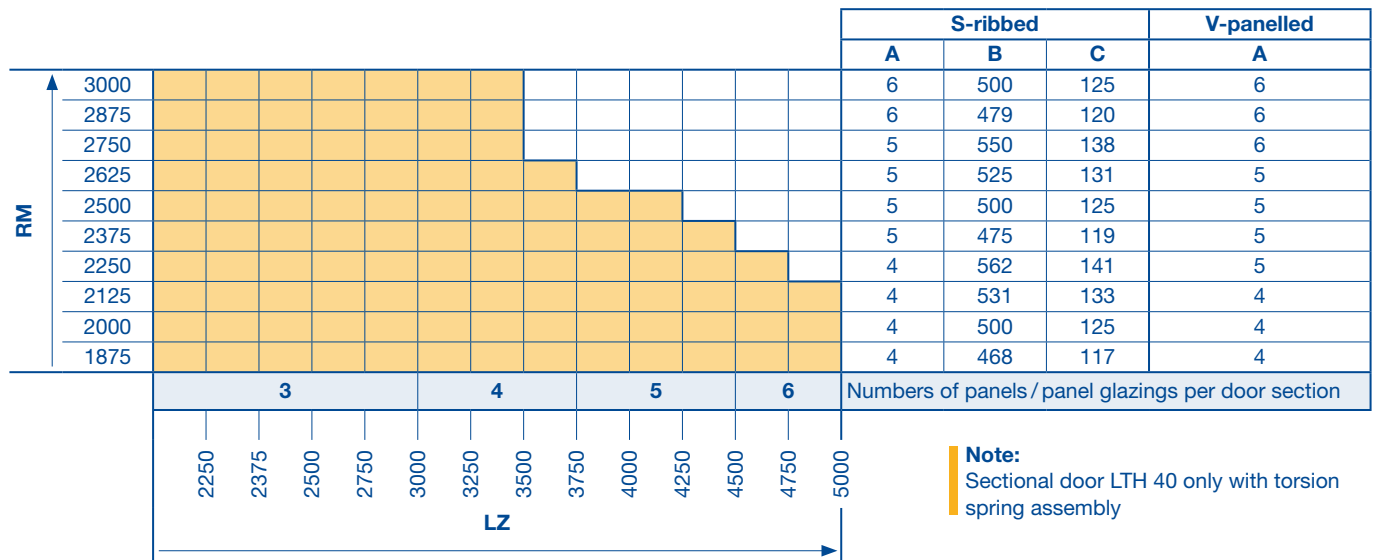

Note:
Sectional door LTH 40 only with torsion spring assembly

- A** No. of door sections
- B** Door section height
- C** Spacing
- RM** Grid height
- LZ** Clear frame dimensions (from 2000)

Ventilation

- Ventilation slots in bottom seal (standard), ventilation cross section 65 cm² for one metre door width

Glazing options (for panelled versions only)

- Panel glazing with clear or crystal structure, 3 mm

Sectional Door LTH 40 with Special Designs

Nordic Pine / Hemlock

External views

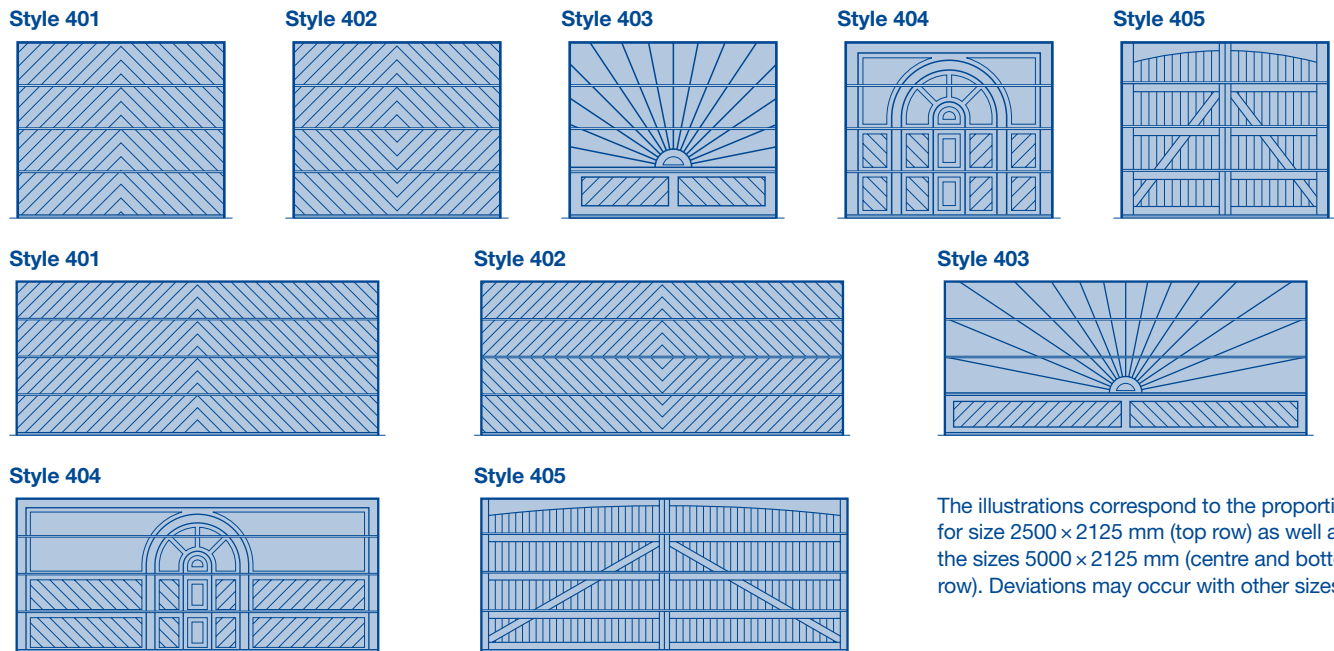

The illustrations correspond to the proportions for size 2500 x 2125 mm (top row) as well as the sizes 5000 x 2125 mm (centre and bottom row). Deviations may occur with other sizes.

Size range

Door width in 10 mm increments. Intermediate heights are possible. Further designs on request.

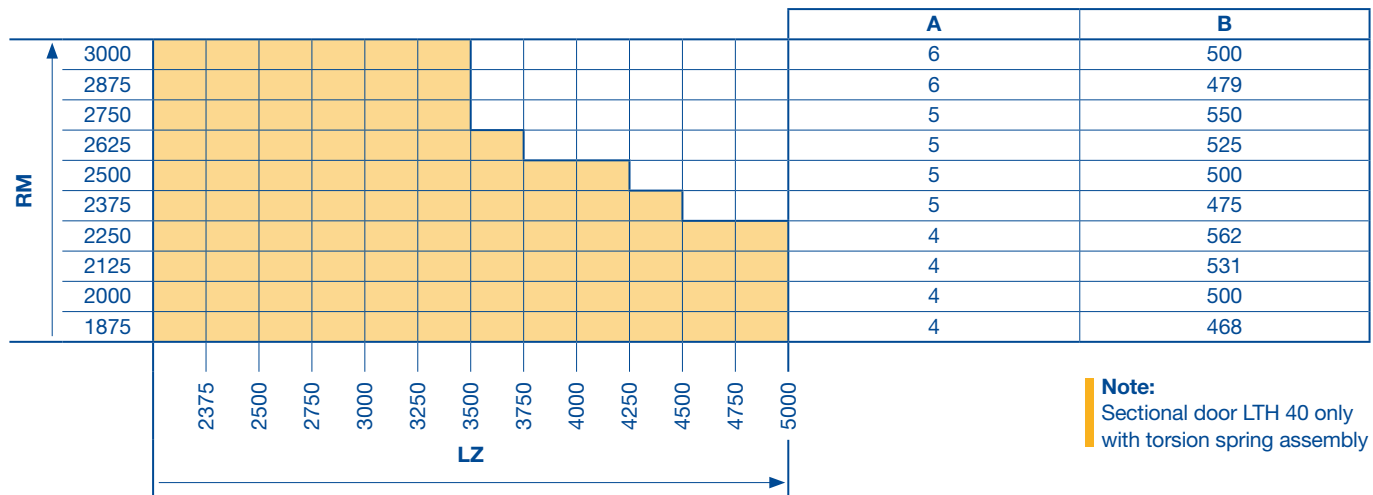

Note:
Sectional door LTH 40 only
with torsion spring assembly

A No. of door sections
B Door section height
RM Grid height
LZ Clear frame dimensions (from 2250)

Ventilation

- Ventilation slots in bottom seal (standard), ventilation cross section 65 cm² for one metre door width

Sectional Door LPU 40

Double-skinned steel sections, fitting in front of the reveal

S-ribbed

Woodgrain

External views

(The illustrations correspond to size 2500 × 2125 mm. Deviations may occur with other sizes.)

Basic model

With aluminium frame
NF / WF

With glazing type D

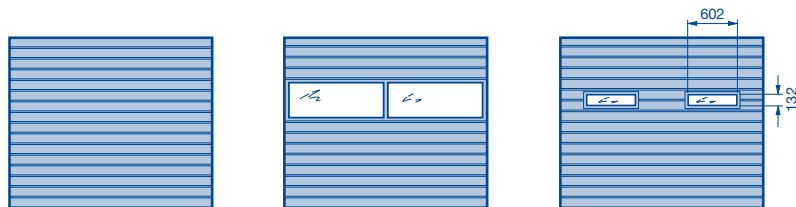

Size range

Door width in 5 mm increments, door height in grid height. Intermediate heights are possible.

														A	B	C				
RM	2205														4	550	138			
	2125														4	531	133			
	2080														4	520	130			
	2000														4	500	125			
	1955														4	488	122			
	1875														4	468	117			
		4		6														No. of ventilation grilles with 40 cm ² ventilation cross section each		
		2		3														Number of infills per door section with glazing		
		2250	2375	2500	2750	3000	3250	3500	3750	4000	4250	4500	4750	5000	LZ					

 Doors up to 3000 × 2500 mm: with tension spring assembly

A No. of door sections

B Door section height

C Spacing

RM Grid height

LZ Clear frame dimensions (from 2000)

Special equipment

Ventilation

- Ventilation slots in bottom seal ventilation cross section 65 cm² for one metre door width
- Ventilation grille, ventilation cross section 40 cm² each
- Aluminium frame with expanded mesh 58 % ventilation cross section

Glazing options

- Aluminium frame (standard profile NF or thermal break profile WF)
- Glazing type D, 16 mm

Sectional Door LPU 40

Double-skinned steel sections, fitting in front of the reveal

M-ribbed

Woodgrain, New Silkgrain or Micrograin

External views

(The illustrations correspond to size 2500 x 2125 mm. Deviations may occur with other sizes.)

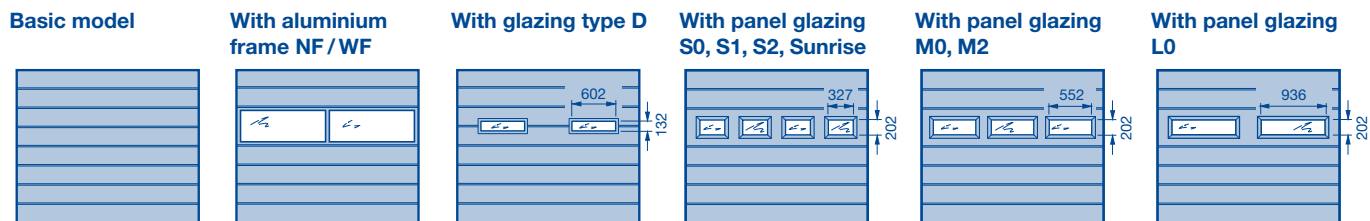

Size range

Door width in 5 mm increments, door height in grid height. Intermediate heights are possible.

														A	B	C	
RM	2205													4	550	275	
	2125													4	531	265	
	2080													4	520	260	
	2000													4	500	250	
	1955													4	488	244	
	1875													4	468	234	
		4	6											No. of ventilation grilles with 40 cm ² ventilation cross section each			
		2	3											No. of glazings – aluminium frame and type D			
3 → 2125		4	5											No. of glazings – type S			
2 → 2240		3												No. of glazings – type M			
		2												No. of glazings – type L			
		2250	2375	2500	2750	3000	3250	3500	3750	4000	4250	4500	4750	5000	LZ		

- A No. of door sections
- B Door section height
- C Spacing
- RM Grid height
- LZ Clear frame dimensions (from 2000)
- Up to width

Special equipment

Ventilation

- Ventilation slots in bottom seal ventilation cross section 65 cm² for one metre door width
- Ventilation grille, ventilation cross section 40 cm² each
- Aluminium frame with expanded mesh 58 % ventilation cross section

Glazing options

- Aluminium frame (standard profile NF or thermal break profile WF)
- Glazing type D, 16 mm
- Panel glazing type S, 22 mm (see page 17)

Sectional Door LPU 40

Double-skinned steel sections, fitting in front of the reveal

L-ribbed

Woodgrain, New Silkgrain or Micrograin

External views

(The illustrations correspond to size 2500 × 2125 mm. Deviations may occur with other sizes.)

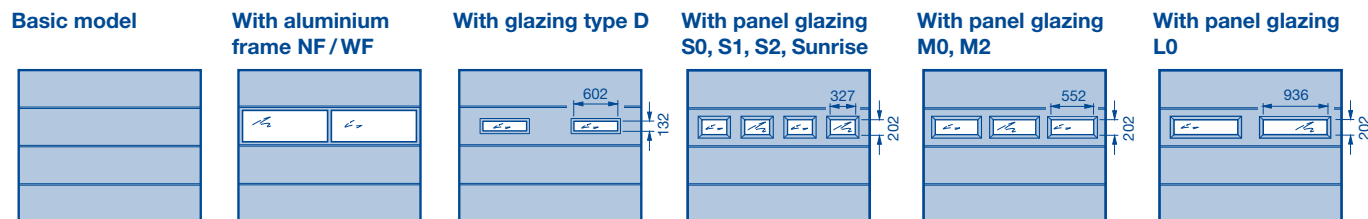

Size range

Door width in 5 mm increments, door height in grid height. Intermediate heights are possible.

												A	B			
RM	2205											4	550			
	2125											4	531			
	2080											4	520			
	2000											4	500			
	1955											4	488			
	1875											4	468			
		4	6											No. of ventilation grilles with 40 cm ² ventilation cross section each		
		2	3											No. of glazings – aluminium frame and type D		
3 → 2125		4	5											No. of glazings – type S		
2 → 2240		3												No. of glazings – type M		
		2												No. of glazings – type L		
		2250	2375	2500	2750	3000	3250	3500	3750	4000	4250	4500	4750	5000	LZ	

A No. of door sections

B Door section height

RM Grid height

LZ Clear frame dimensions (from 2000)

→ Up to width

Special equipment

Ventilation

- Ventilation slots in bottom seal
ventilation cross section 65 cm² for one metre door width
- Ventilation grille, ventilation cross section 40 cm² each
- Aluminium frame with expanded mesh
58 % ventilation cross section

Glazing options

- Aluminium frame (standard profile NF or thermal break profile WF)
- Glazing type D, 16 mm
- Panel glazing type S, 22 mm (see page 17)

Sectional Door LPU 40

Double-skinned steel sections, fitting in front of the reveal

S-panelled

Woodgrain

External views

(The illustrations correspond to size 2500 x 2125 mm. Deviations may occur with other sizes.)

Basic model

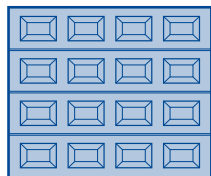

Style S0

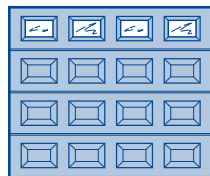

Style S1 with decorative rail (rhombus)

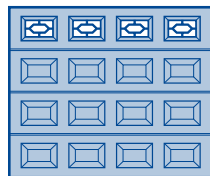

Style S2 with decorative rail (cross)

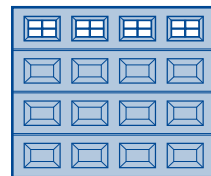

Style S10

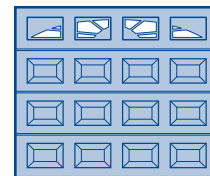

Size range

Door width in 5 mm increments, door height in grid height. Intermediate heights are possible.

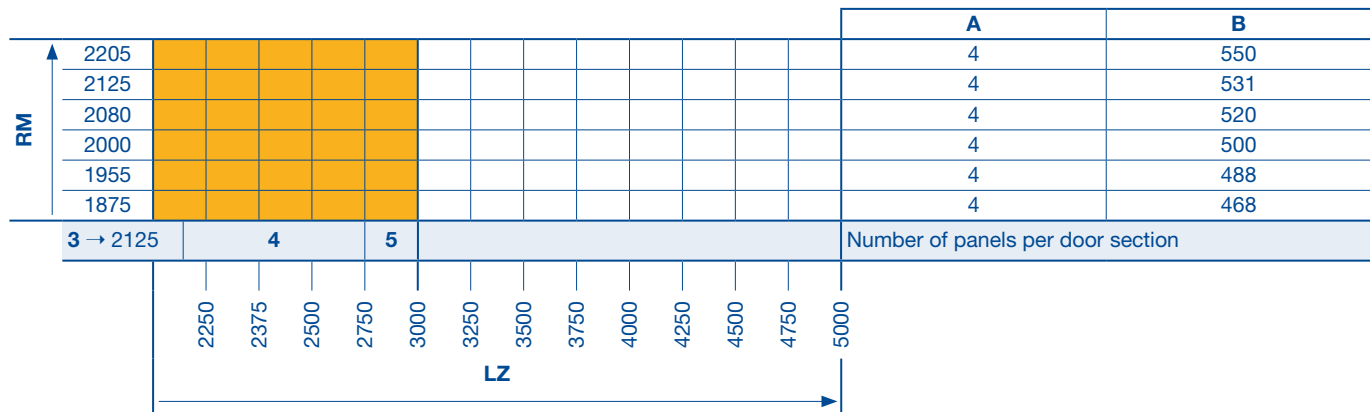

- A** No. of door sections
- B** Door section height
- RM** Grid height
- LZ** Clear frame dimensions (from 2000)
- Up to width

Special equipment

Ventilation

- Ventilation slots in bottom seal, ventilation cross section 65 cm² for one metre door width

Glazing options - Panel glazing

- Clear or crystal structure double panes, 16 mm
- Styles S0, S1, S2
- Designs S10, S20 (see page 17)

Track Applications: Z

Z: Tension spring track application

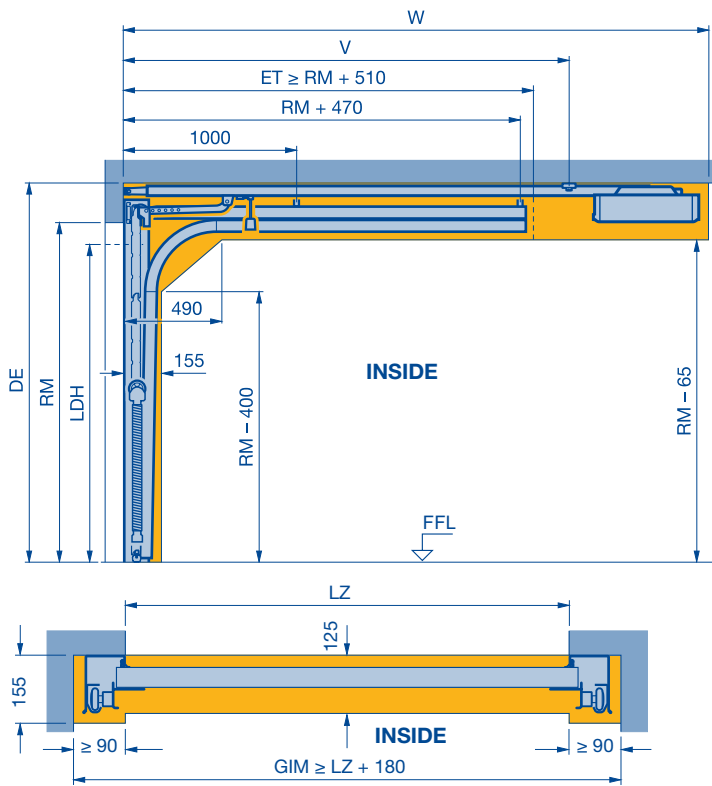

RM Height	Manual operation		With operator		
	Min. DE	LDH	Min. DE	Min. DE with Thermo Frame	LDH
	RM + 100	RM - 80	RM + 115	RM + 145	RM - 30
1875	1975	1795	1990	2020	1845
1955	2055	1875	2070	2100	1925
2000	2100	1920	2115	2145	1970
2080	2180	2000	2195	2225	2050
2125	2225	2045	2240	2270	2095
2205	2305	2125	2320	2350	2175
2250	2350	2170	2365	2395	2220
2375	2475	2295	2490	2520	2345
2500	2600	2420	2615	2645	2470
2625	2725	2545	2740	2765	2595

- LDH** Clear passage height
- RM** Grid height
- LZ** Clear frame dimensions
- DE** Ceiling height
Max. DE with track suspension set = RM + 740
- ET** Distance back
- GIM** Inside garage dimension

Note:
The clearance for fitting and subsequent operation of the door must be complied with.

ProMatic	V	W
With short boom (K) up to door height 2125	2775	3200
With medium boom (M) up to door height 2375	3025	3450
With long boom (L) up to door height 3000	3700	4125
With special length boom on request		

Track Application: N

N: Normal track application

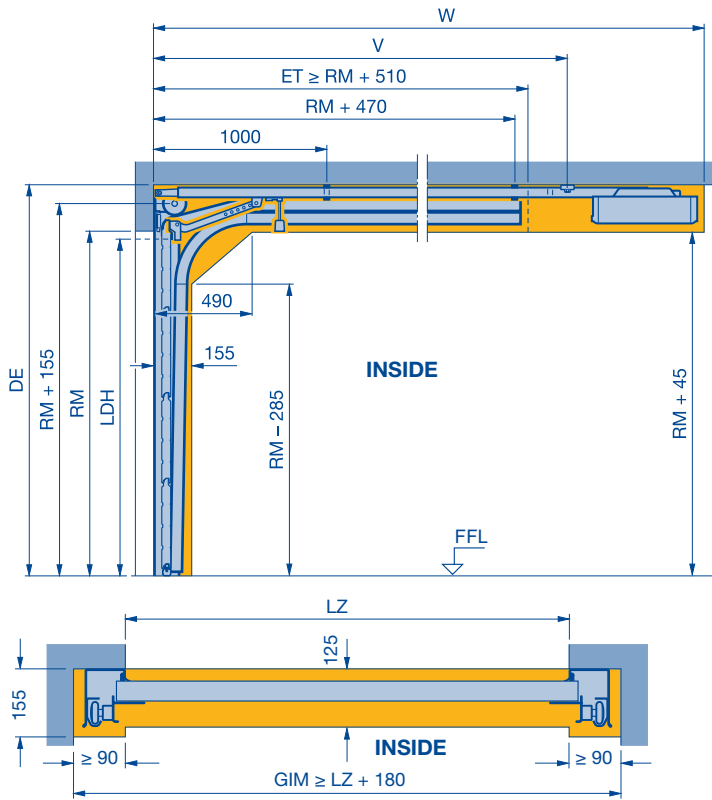

RM Height	Manual operation		With operator		
	Min. DE	LDH	Min. DE	Min. DE with Thermo Frame	LDH
	RM + 210	RM - 50	RM + 210	RM + 255	RM
1875	2085	1825	2085	2130	1875
1955	2165	1905	2165	2210	1955
2000	2210	1950	2210	2255	2000
2080	2290	2030	2290	2335	2080
2125	2335	2075	2335	2380	2125
2205	2415	2155	2415	2460	2205
2250	2460	2200	2460	2505	2250
2375	2585	2325	2585	2630	2375
2500	2710	2450	2710	2755	2500
2625	2835	2575	2835	2880	2625
2750	2960	2700	2960	3005	2750
2875	3085	2825	3085	3130	2875
3000	3210	2950	3210	3255	3000

- LDH** Clear passage height
- RM** Grid height
- LZ** Clear frame dimensions
- DE** Ceiling height
Max. DE with track suspension set = RM + 850
- ET** Distance back
- GIM** Inside garage dimension

Note:
The clearance for fitting and subsequent operation of the door must be complied with.

ProMatic, SupraMatic E, P and H	V	W
With short boom (K) up to door height 2250	2775	3200
With medium boom (M) up to door height 2500	3025	3450
With long boom (L) up to door height 3000	3700	4125
With special length boom on request		

Track Application: L

L: Low headroom track application

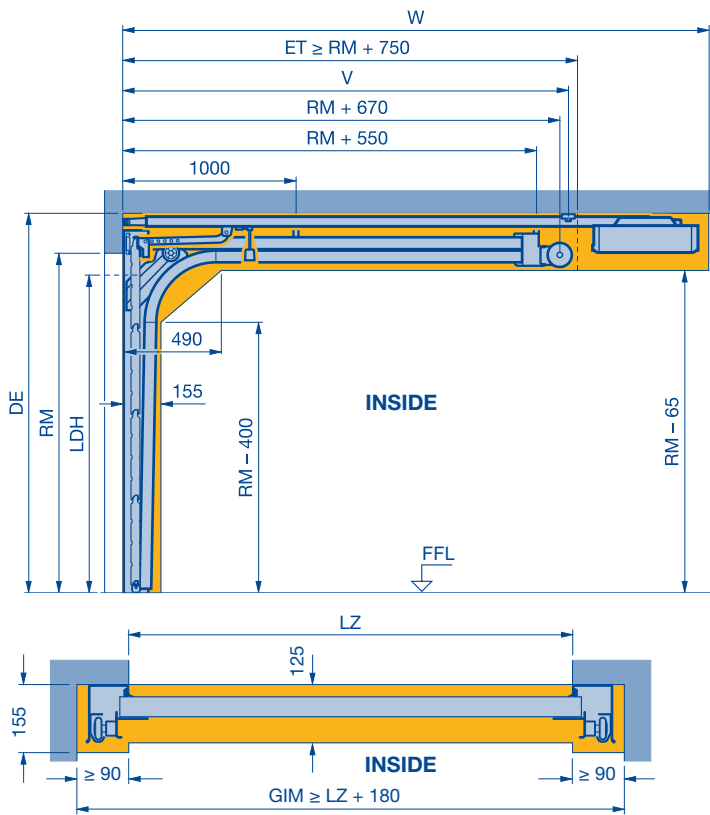

RM Height	Manual operation		With operator			
	Min. DE	LDH	Min. DE	Min. DE with Thermo Frame	LDH Up to LZ=3000 mm	LDH From LZ=3010 mm
	RM + 100	RM - 100	RM + 115	RM + 145	RM - 30	RM - 80
1875	1975	1775	1990	2020	1845	1795
1955	2055	1855	2070	2100	1925	1875
2000	2100	1900	2115	2145	1970	1920
2080	2180	1980	2195	2225	2050	2000
2125	2225	2025	2240	2270	2095	2045
2205	2305	2105	2320	2350	2175	2125
2250	2350	2150	2365	2395	2220	2170
2375	2475	2275	2490	2520	2345	2295
2500	2600	2400	2615	2645	2470	2420
2625	2725	2525	2740	2790	2595	2545
2750	2850	2650	2865	2895	2720	2670
2875	2975	2775	2990	3020	2845	2795
3000	3100	2900	3115	3145	2970	2920

- LDH** Clear passage height
- RM** Grid height
- LZ** Clear frame dimensions
- DE** Ceiling height
Max. DE with track suspension set = RM + 740
- ET** Distance back
- GIM** Inside garage dimension

Note:

The clearance for fitting and subsequent operation of the door must be complied with.

Note:

For DE > RM + 285 an additional 120 x 60 extrusion is required to strengthen the suspension construction in the area of the torsion springs.

ProMatic, SupraMatic E, P and H	V	W
With short boom (K) up to door height 2125	2775	3200
With medium boom (M) up to door height 2375	3025	3450
With long boom (L) up to door height 3000	3700	4125
With special length boom on request		

Track Application: H

H: High-lift track application

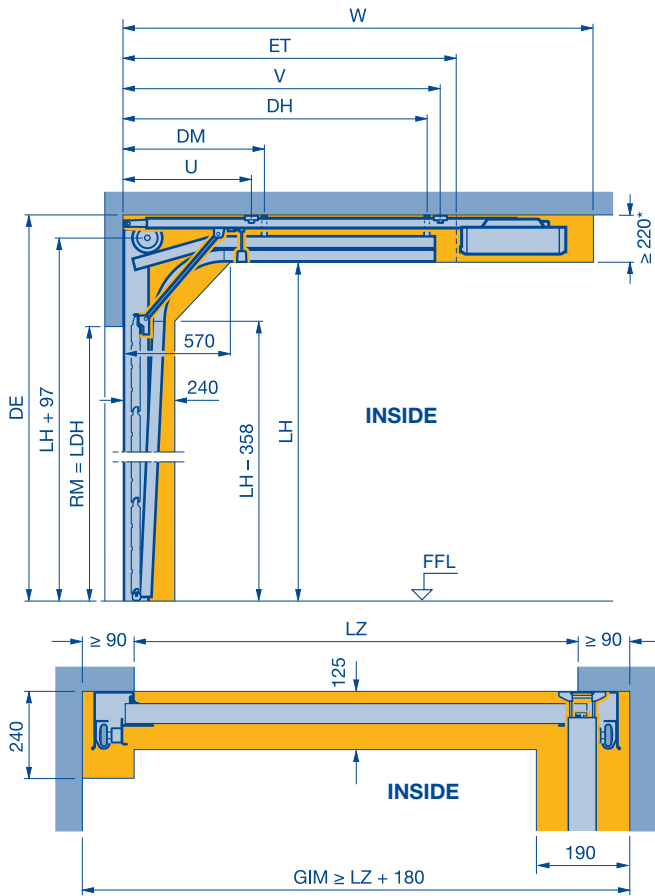

Not for EPU 40 or versions with wicket door.
For LTH 40 doors, a SupraMatic operator is required.

Door height RM Height	Track height			
	(1) with spring buffer		(2) with buffer stop	
	Min.	Max.	Min.	Max.
1875	2260	2634	2635	3190
1955	2340	2714	2715	3270
2000	2385	2759	2760	3315
2080	2465	2839	2840	3395
2125	2510	2884	2885	3440
2205	2590	2964	2965	3520
2250	2635	3009	3010	3565
2375	2760	3134	3135	3690
2500	2885	3259	3260	3815
2625	3010	3384	3385	3940
2750	3135	3509	3510	4065
2875	3315	3634	3635	4190
3000	3565	3759	3760	4315

- LDH** Clear passage height
- RM** Grid height
- LF** Structural opening
- LH** Track height
- LZ** Clear frame dimensions
- DE** Ceiling height
- DH** Rear ceiling anchor = $ET - 200$
- DM** Centre ceiling anchor = $DH / 2$
- ET** Distance back
(1) = $2 \times RM + 690 - LH$
(2) = $2 \times RM + 490 - LH$
- GIM** Minimum inside garage dimension
* With ThermoFrame ≥ 255

Note:
The clearance for fitting and subsequent operation of the door must be complied with.

ProMatic, SupraMatic E, P and H	U	V	W	Length of operator boom
With short boom (K) up to door height 2125	1100	2775	3200	3000
With medium boom (M) up to door height 2375	1100	3025	3450	3250
With long boom (L) up to door height 3000	1300	3700	4125	3925
With special length boom on request				

Track Application: N

(LPU 40) Wicket door

N: Normal track application

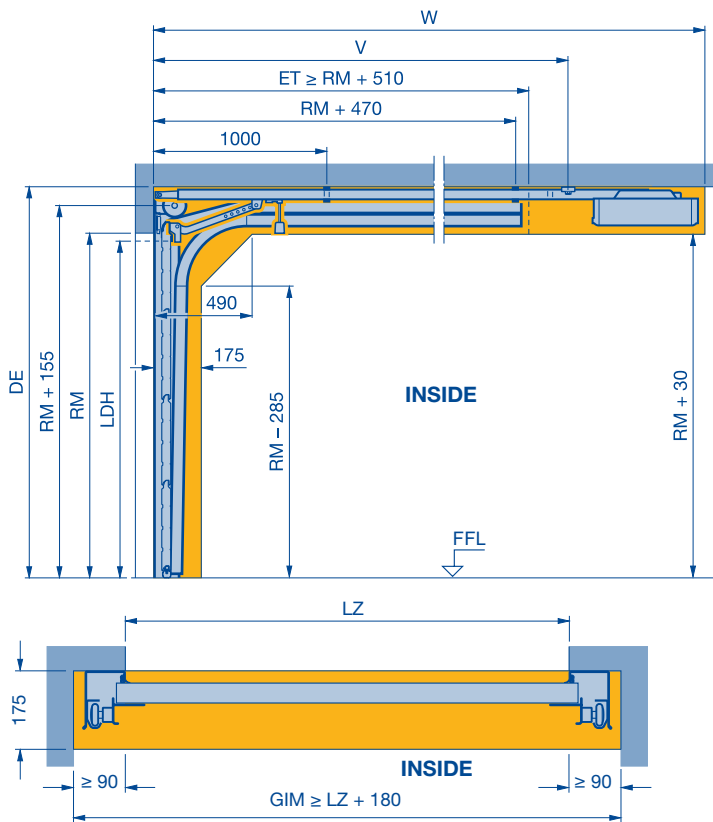

RM Height	Manual operation		With operator		
	Min. DE	LDH	Min. DE	Min. DE with Thermo Frame	LDH
	RM + 220	RM - 160	RM + 235	RM + 255	RM - 100
1875	2095	1715	2110	2130	1775
1955	2175	1795	2190	2210	1855
2000	2220	1840	2235	2255	1900
2080	2300	1920	2315	2335	1980
2125	2345	1965	2360	2380	2025
2205	2425	2045	2440	2460	2105
2250	2470	2090	2485	2505	2150
2375	2595	2215	2610	2630	2275
2500	2720	2340	2735	2755	2400
2625	2845	2465	2860	2880	2525
2750	2970	2590	2985	3005	2650
2875	3095	2715	3110	3130	2775
3000	3220	2840	3235	3255	2900

- LDH** Clear passage height
- RM** Grid height
- LZ** Clear frame dimensions
- DE** Ceiling height
Max. DE with track suspension set = RM + 740
- ET** Distance back
- GIM** Inside garage dimension

Note:
The clearance for fitting and subsequent operation of the door must be complied with.

Note:
Due to the low threshold height, the ground in front of the garage must be level or sloped to guarantee smooth opening of the wicket door (opening outwards) – see page 43.

Note:
For doors up to RM 2250 in S-panelled versions or in S, M or L-ribbed versions and top glazing type D, S and M, the distance from FFL to the bottom edge of the lintel must be equal to or greater than the ordering size (RM).
Deviating sizes on request!

ProMatic, SupraMatic E, P and H	V	W
With short boom (K) up to door height 2250	2775	3200
With medium boom (M) up to door height 2500	3025	3450
With long boom (L) up to door height 3000	3700	4125
With special length boom on request		

Track application: L

(LPU 40) Wicket door

L: Low headroom track application

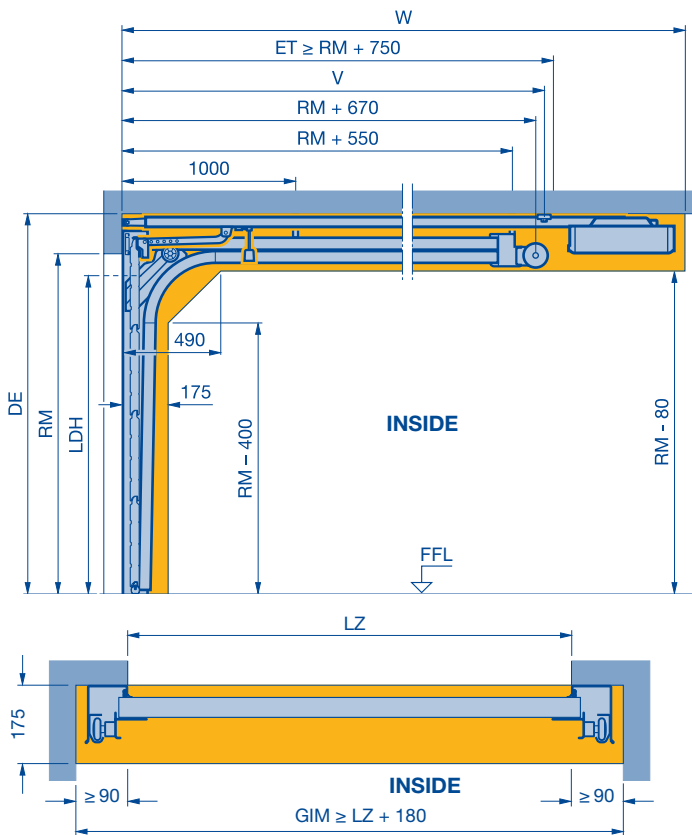

RM Height	Manual operation		With operator		
	Min. DE	LDH	Min. DE	Min. DE with Thermo Frame	LDH
	RM + 125	RM - 160	RM + 125	RM + 145	RM - 160
1875*	2000	1715	2000	2020	1715
1955	2080	1795	2080	2100	1795
2000	2125	1840	2125	2145	1840
2080	2205	1920	2205	2225	1920
2125	2250	1965	2250	2270	1965
2205	2330	2045	2330	2350	2045
2250	2375	2090	2375	2395	2090
2375	2500	2215	2500	2520	2215
2500	2625	2340	2625	2645	2340
2625	2750	2465	2750	2770	2465
2750	2875	2590	2875	2895	2590
2875	3000	2715	3000	3020	2715
3000	3125	2840	3125	3145	2840

* These versions are only available for S/M/L-ribbed doors

LDH	Clear passage height
RM	Grid height
LZ	Clear frame dimensions
DE	Ceiling height
	Max. DE with track suspension set = RM + 740
ET	Distance back
GIM	Inside garage dimension

Note:

The clearance for fitting and subsequent operation of the door must be complied with.

Note:

For DE > RM + 285 an additional 120 × 60 extrusion is required to strengthen the suspension construction in the area of the torsion spring.

Note:

Due to the low threshold height, the ground in front of the garage must be level or sloped to guarantee smooth opening of the wicket door (opening outwards) – see page 43.

Note:

For doors up to RM 2250 in S-panelled versions or in S, M or L-ribbed versions and top glazing type D, S and M, the distance from FFL to the bottom edge of the lintel must be equal to or greater than the ordering size (RM). Deviating sizes on request!

ProMatic, SupraMatic E, P and H	V	W
With short boom (K) up to door height 2125	2775	3200
With medium boom (M) up to door height 2375	3025	3450
With long boom (L) up to door height 3000	3700	4125
With special length boom on request		

Track Application: BZ

BZ: track application Z/track application for flush-fitting panel

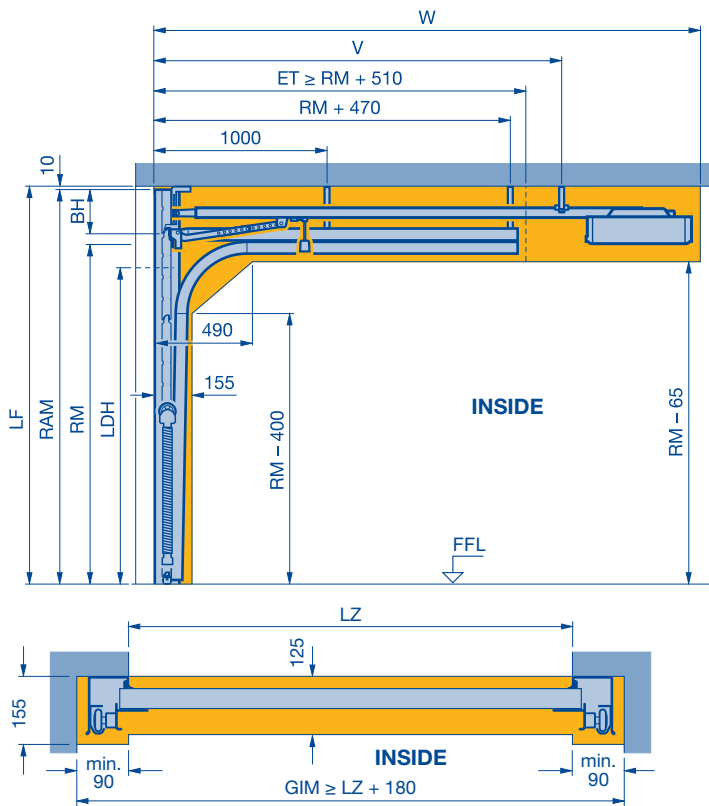

RM Height	RAM		Manual operation	With operator
	Min. RM + 240	Max.	LDH RM - 80	LDH RM - 30
1875	2115	2379	1795	1845
1955	2195	2479	1875	1925
2000	2240	2539	1920	1970
2080	2320	2639	2000	2050
2125	2365	2694	2045	2095
2205	2445	2789	2125	2175
2250	2490	2849	2170	2220
2375	2615	2889	2295	2345
2500	2740	3039	2420	2470
2625	2865	3189	2545	2595

- LDH** Clear passage height
- RM** Grid height
- LZ** Clear frame dimensions
- DE** Ceiling height
- ET** Min. distance back = RM + 440
- GIM** Inside garage dimension
- BH** Panel height
- RAM** Overall frame dimension = ordering size
- Min. RAM = RM + 240
- Max. RAM = 3189
- LF** Structural opening

Note:
The clearance for fitting and subsequent operation of the door must be complied with.

Note:
Shortened top door section or top aluminium frame is not possible.

ProMatic	V	W
With short boom (K) up to door height 2125	2847	3272
With medium boom (M) up to door height 2375	3097	3522
With long boom (L) up to door height 3000	3772	4197
With special length boom on request		

Track Application: BL

BL: track application L / track application for flush-fitting panel

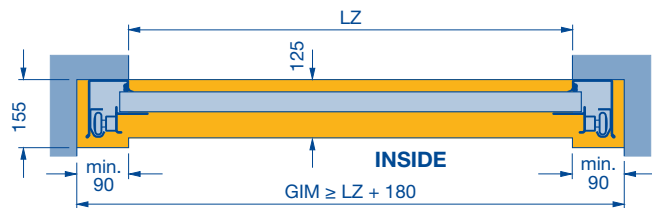
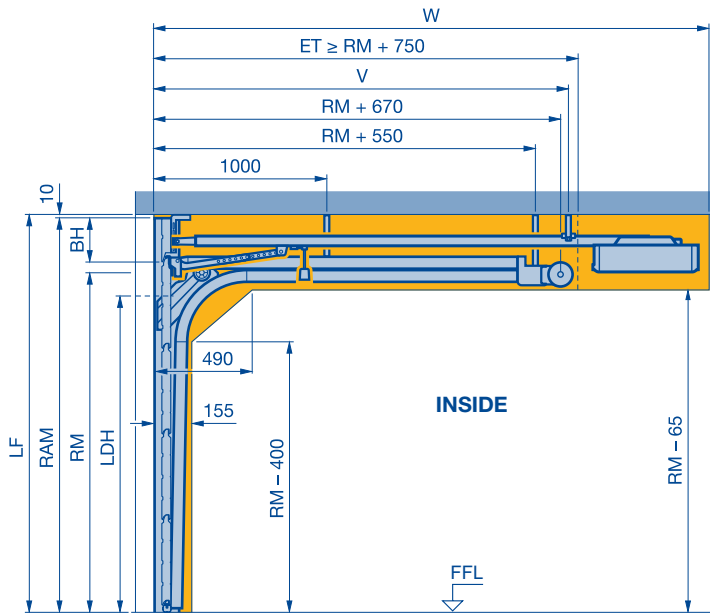

RM Height	RAM		Manual operation	With operator	
	Min.	Max.	LDH	LDH up to LZ ≤ 3000	LDH from LZ ≥ 3010
	RM + 240		RM - 100	RM - 30	RM - 80
1875	2115	2379	1775	1845	1795
1955	2195	2479	1855	1925	1875
2000	2240	2539	1900	1970	1920
2080	2320	2639	1980	2050	2000
2125	2365	2694	2025	2095	2045
2205	2445	2789	2105	2175	2125
2250	2490	2849	2150	2220	2170
2375	2615	2889	2275	2345	2295
2500	2740	3039	2400	2470	2420
2625	2865	3189	2525	2595	2545
2750	2990	3339	2650	2720	2670
2875	3115	3392	2775	2845	2795
3000	3240	3539	2900	2970	2920

- LDH** Clear passage height
- RM** Grid height
- LZ** Clear frame dimensions
- DE** Ceiling height
- ET** Distance back
- GIM** Inside garage dimension
- BH** Panel height
- RAM** Overall frame dimension = ordering size
Min. RAM = RM + 240
Max. RAM = 3539
- LF** Structural opening

Note:
The clearance for fitting and subsequent operation of the door must be complied with.

Note:
Shortened top door section or top aluminium frame is not possible.

ProMatic, SupraMatic E, P and H	V	W
With short boom (K) up to door height 2125	2847	3272
With medium boom (M) up to door height 2375	3097	3522
With long boom (L) up to door height 3000	3772	4197
With special length boom on request		

Track Application: BL

(LPU 40) Wicket door

BL: track application L / track application for flush-fitting panel

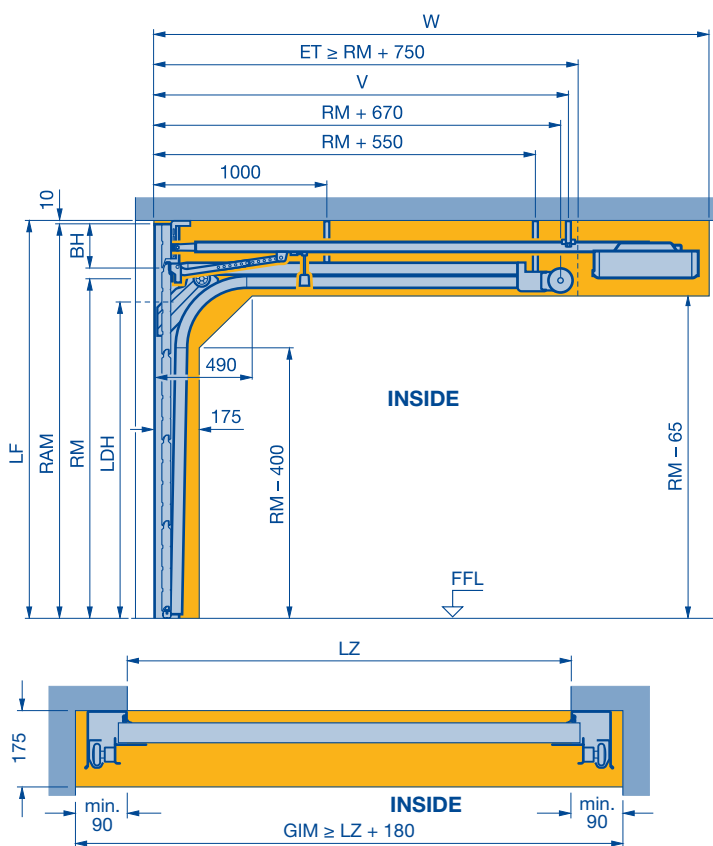

RM Height	RAM		Manual operation	With operator
	Min. RM + 240	Max.	LDH RM - 160	LDH RM - 160
1875	2115	2379	1715	1715
1955	2195	2479	1795	1795
2000	2240	2539	1840	1840
2080	2320	2639	1920	1920
2125	2365	2694	1965	1965
2205	2445	2789	2045	2045
2250	2490	2849	2090	2090
2375	2615	2889	2215	2215
2500	2740	3039	2340	2340
2625	2865	3189	2465	2465
2750	2990	3339	2590	2590
2875	3115	3392	2715	2715
3000	3240	3539	2840	2840

- LDH** Clear passage height
- RM** Grid height
- LZ** Clear frame dimensions
- DE** Ceiling height
- ET** Distance back
- GIM** Inside garage dimension
- BH** Panel height
- RAM** Overall frame dimension = ordering size
Min. RAM = RM + 240
Max. RAM = 3539
- LF** Structural opening

- Note:** The clearance for fitting and subsequent operation of the door must be complied with.
- Note:** Due to the low threshold height, the ground in front of the garage must be level or sloped to guarantee smooth opening of the wicket door (opening outwards) – see page 43.
- Note:** Shortened top door section or top aluminium frame is not possible.

ProMatic, SupraMatic E, P and H	V	W
With short boom (K) up to door height 2125	2847	3272
With medium boom (M) up to door height 2375	3097	3522
With long boom (L) up to door height 3000	3772	4197
With special length boom on request		

Clearance for lintel fitting with flush-fitting panel

Without lintel

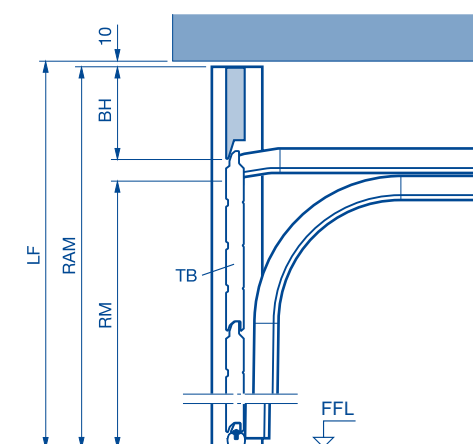

With lintel

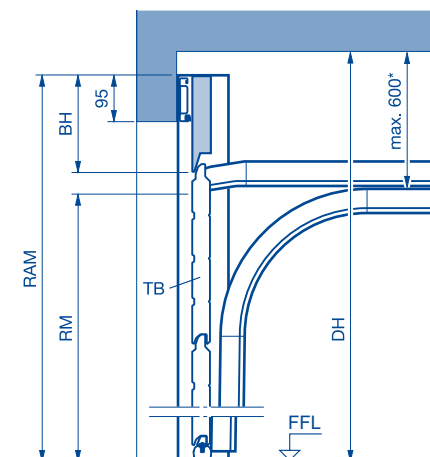

Track application	Panel version
BZ and BL	PU fascia, S, M and L-ribbed
	S-panelled on request

- DH** Ceiling height
- TB** Door leaf
- *** Suspension = DH - RM = max. 600 mm

Track Application: Z

Fitting in front of the reveal

Z: Tension spring track application

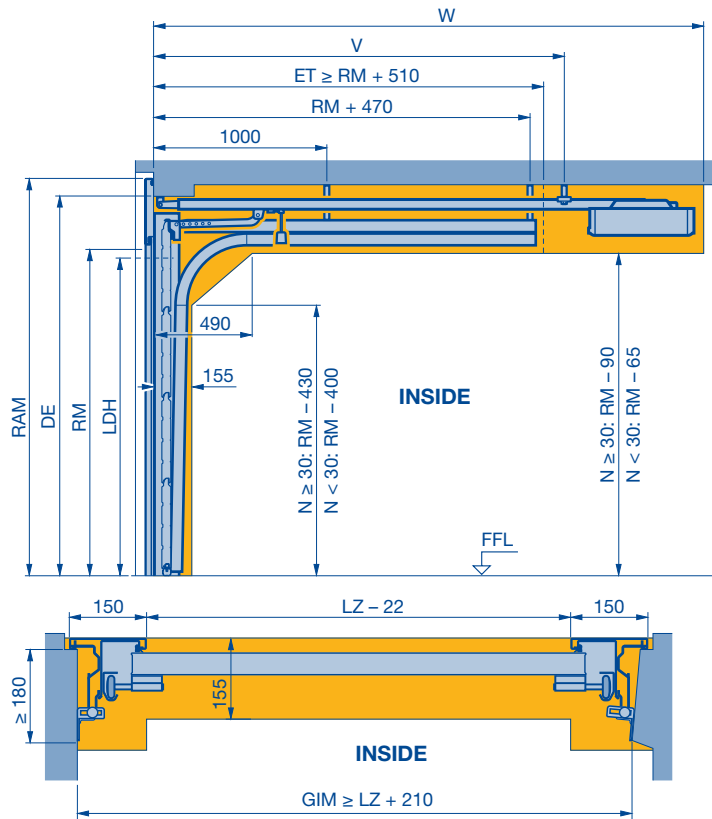

RM Height	N ≥ 30			
	Manual operation		With operator	
	Min. DE RM + 75	LDH RM - 110	Min. DE RM + 90	LDH RM - 60
1875	1950	1765	1965	1815
1955	2030	1845	2045	1895
2000	2075	1890	2090	1940
2080	2155	1970	2170	2020
2125	2200	2015	2215	2065
2205	2280	2095	2295	2145

RM Height	N < 30			
	Manual operation		With operator	
	Min. DE RM + 100	LDH RM - 80	Min. DE RM + 115	LDH RM - 30
1875	1975	1795	1990	1845
1955	2055	1875	2070	1925
2000	2100	1920	2115	1970
2080	2180	2000	2195	2050
2125	2225	2045	2240	2095
2205	2305	2125	2320	2175

- LDH** Clear passage height
 - RM** Grid height
 - LZ** Clear frame dimensions
 - DE** Ceiling height
 - ET** Distance back
 - GIM** Inside garage dimension
 - N** Height difference between interior and exterior garage floor
 - RAM** Overall frame dimension
- RAM** Min. = RM + 115 mm
height Max. = RM + 185 mm

Examples for fitting situation

With N ≥ 30 mm

LDH = RM - 110 mm without operator

With N < 30 mm

LDH = RM - 80 mm without operator

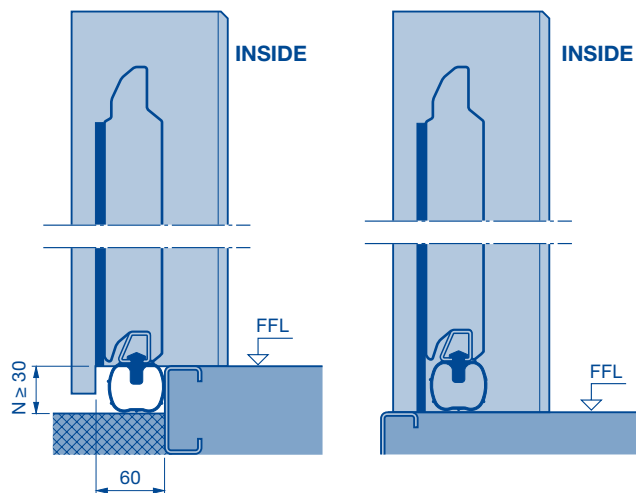

Distance back without operator:

RM + 510 mm

Note:

The clearance for fitting and subsequent operation of the door must be complied with.

ProMatic, SupraMatic E, P and H	V	W
With short boom (K) up to door height 2125	2775	3200
With medium boom (M) up to door height 2375	3025	3450

Sideroom

Track applications Z, N, L, H

Normal track application, **sideroom 90 mm**, fixing inside the frame

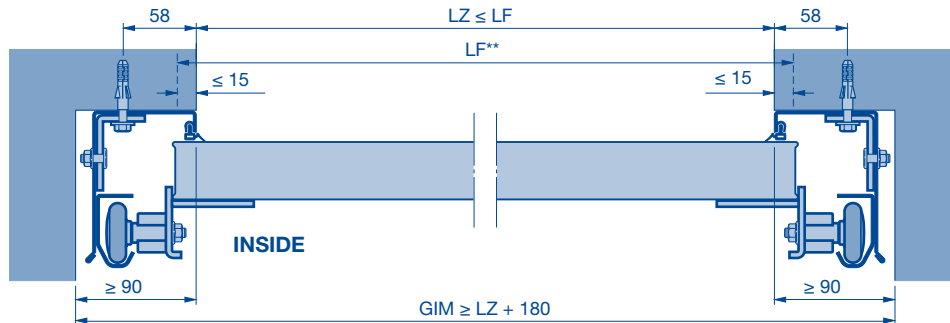

Sideroom less than 75 mm, or without sideroom. Frame fixing using special anchor

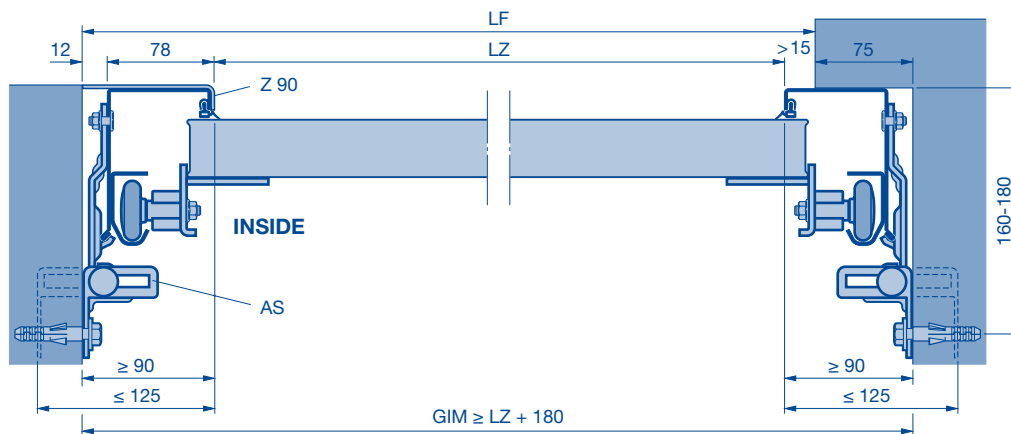

Min. sideroom 75 mm, fixing outside the frame

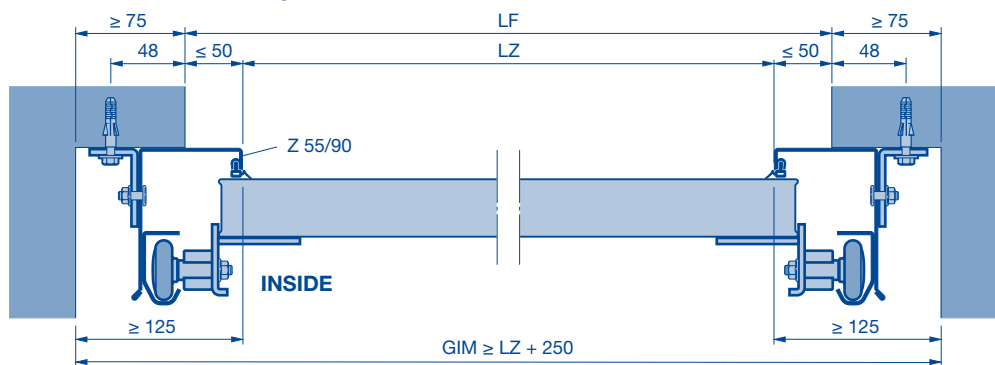

Frame fixing to tube with fixed element using special anchor

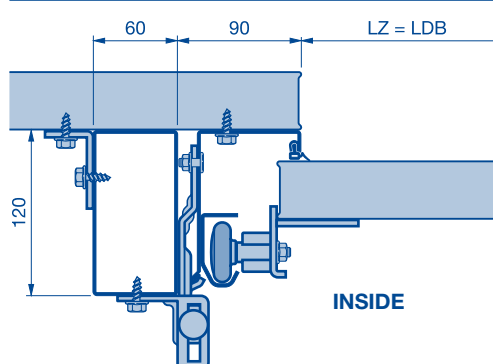

Frame fixing when using a thermal insulation composite system

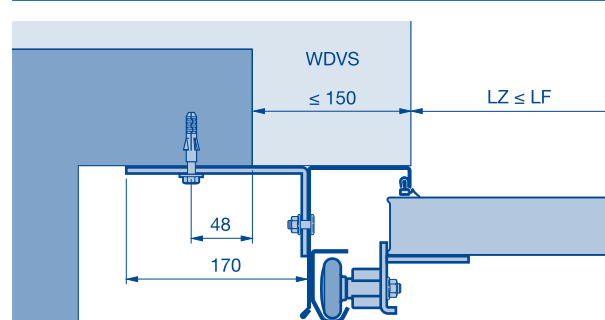

(See next page for the legend)

Sideroom and Lintel Fitting with ThermoFrame

Track applications Z, N, L, H with ThermoFrame

Normal track application, **sideroom 90 mm**, fixing inside the frame

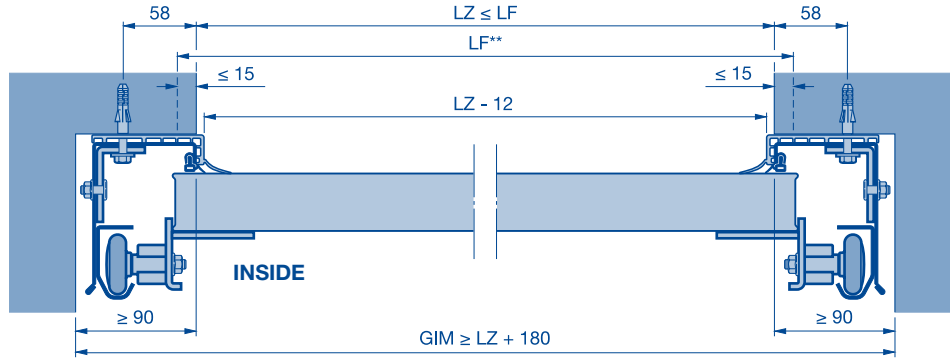

Sideroom less than 75 mm, or without sideroom. Frame fixing using special anchor

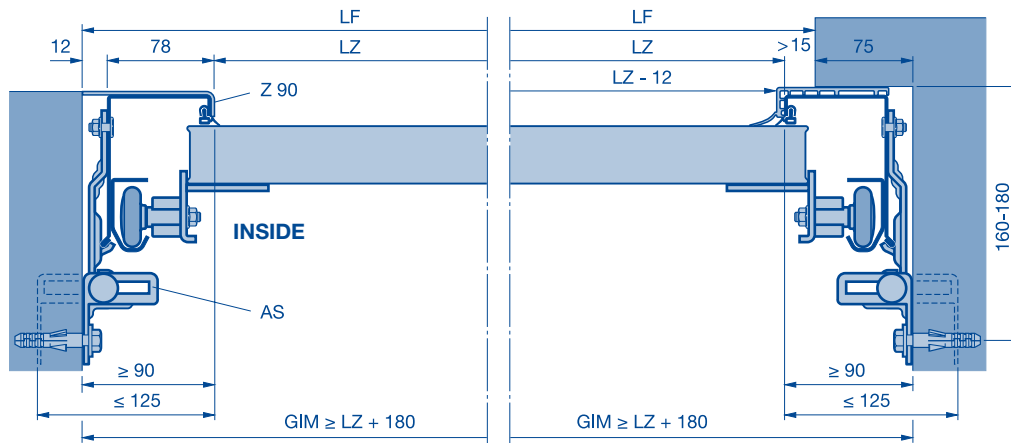

Lintel fitting with ThermoFrame

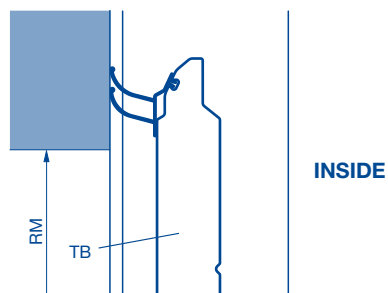

- * Min.
- ** Max.
- LZ Clear frame dimensions
- LF Structural opening
- GIM Inside garage dimension
- Z 55 Frame covering 55

- Z 90 Frame covering 90
- AS Special anchor
- RAMB Overall frame dimension width
- TB Door leaf
- WDVS Thermal insulation composite system

Sideroom

Fitting in front of the reveal

Fitting in front of the reveal

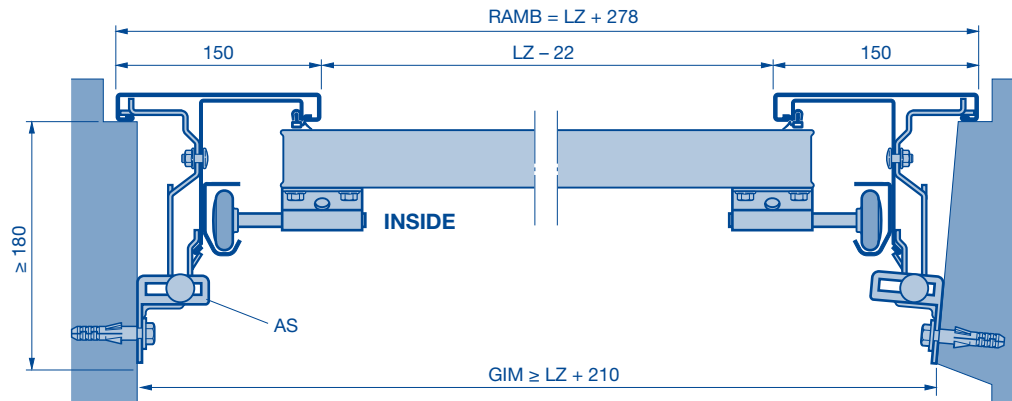

Fitting in the opening

Fascia frame -95-

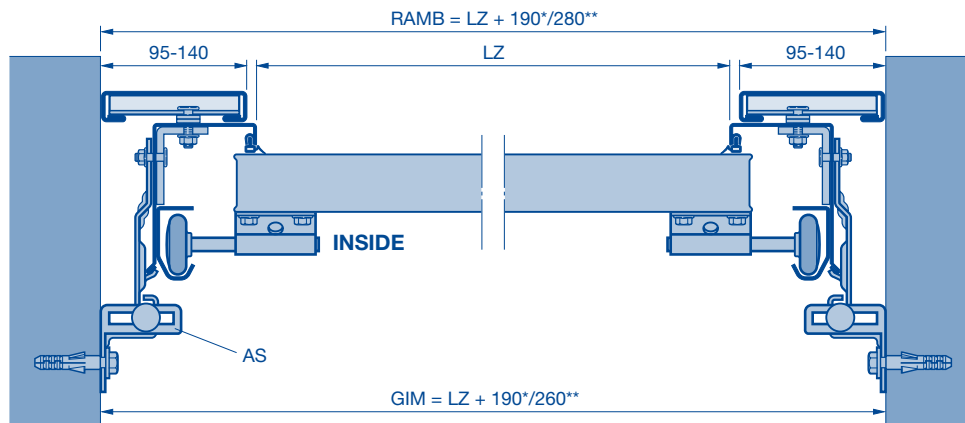

Fitting behind the opening

Retrofit fascia

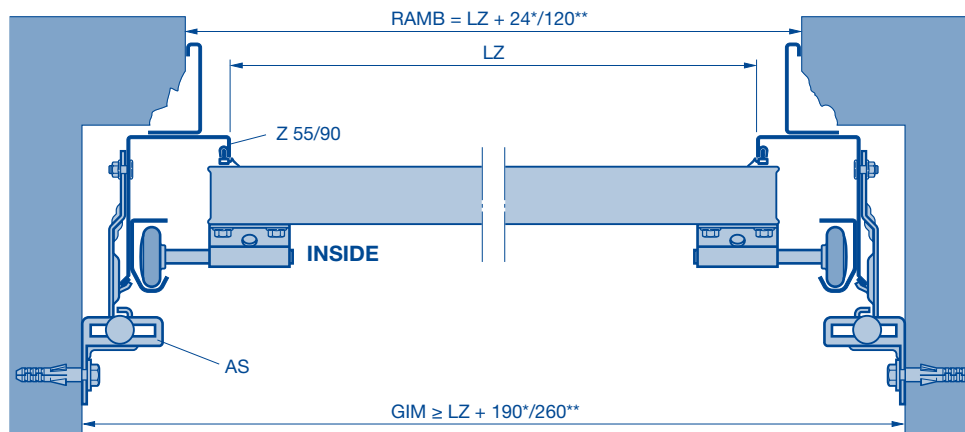

- * Min.
- ** Max.
- LZ Clear frame dimensions
- LF Structural opening
- GIM Inside garage dimension
- Z 55 Frame covering 55
- Z 90 Frame covering 90
- AS Special anchor
- RAMB Overall frame dimension width
- TB Door leaf

Lintel Fitting with Fascia Panels

LTE 40, EPU 40, LPU 40

View A

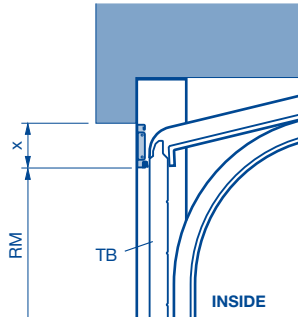

View B

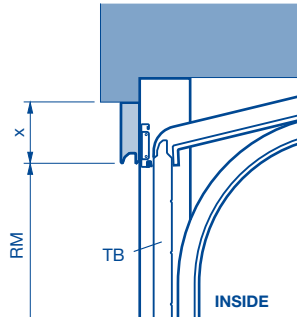

View C

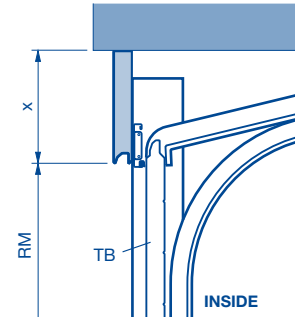

Track application	Panel version	Dimension x		
		View A	View B	View C
Z, N and L	Steel fascia (in scope of delivery)	Up to 100 mm	-	-
	PU panel, S/L-ribbed	-	61 – 562 mm	61 – 562 mm
	PU fascia, M-ribbed	-	250 – 562 mm	250 – 562 mm
	PU fascia, S-panelled	-	-	468, 475, 479, 488, 500, 520, 525, 531, 550, 562

LTH 40 (A steel fascia is included in the scope of delivery for LTH 40 doors!)

View A

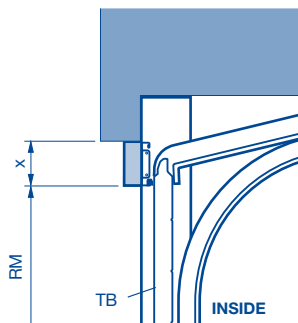

View B

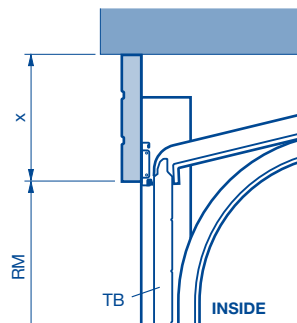

View C

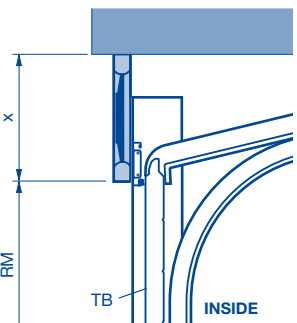

Track application	Panel version	Dimension x		
		View A	View B	View C
N and L	Smooth timber panel	31 – 290 mm	-	-
	Timber panel, S-ribbed	-	146 – 562 mm	-
	Timber panel, V-panelled	-	-	291 – 562 mm

LTE 40, LPU 40

Retrofit fascias

Fascia frame -95-

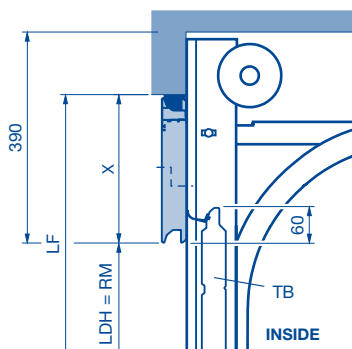

Angle section

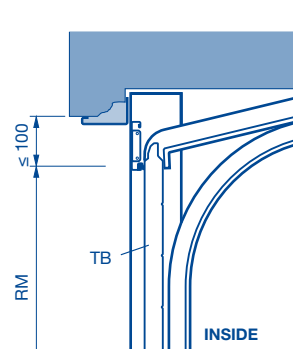
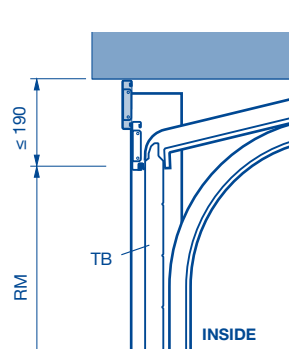

Track applications N, ND, L as industry version (galvanized frame)	Dimension x
PU fascia, S/L-ribbed	100 – 562 mm
PU fascia, M-ribbed	250 – 562 mm
PU fascia, S-panelled	468, 475, 479, 488, 500, 520, 525, 531, 550, 562

Attention:

Observe the frame's plug and screw fitting points in the lintel area, since they are subject to an increased torque with track application N (torsion spring).

TB Door leaf
RM Grid height

LDH Clear passage height
LF Structural opening

Bottom Edge

Without wicket door

with wicket door

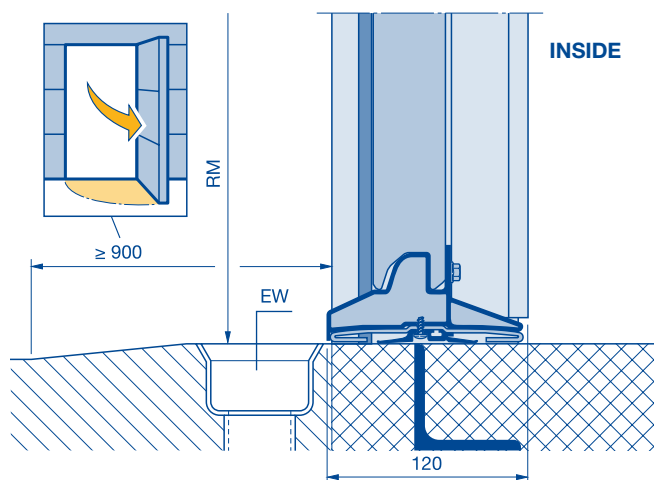
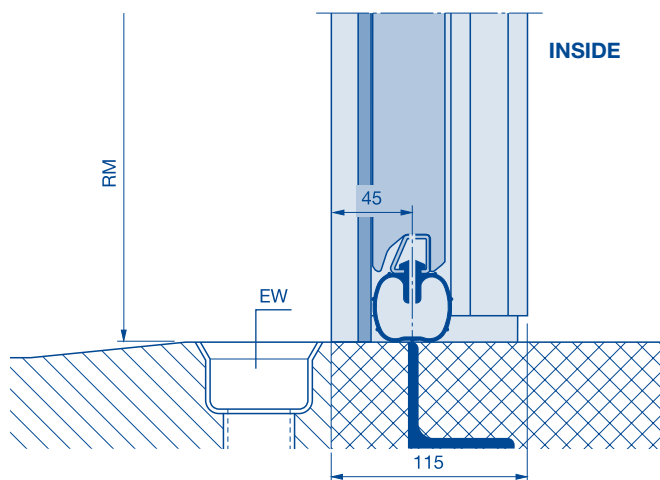
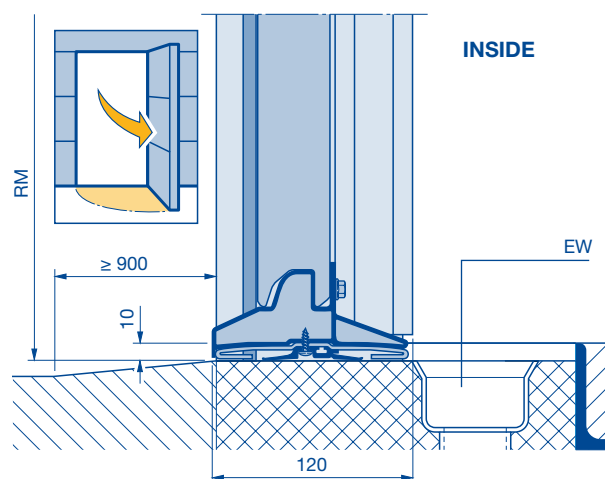
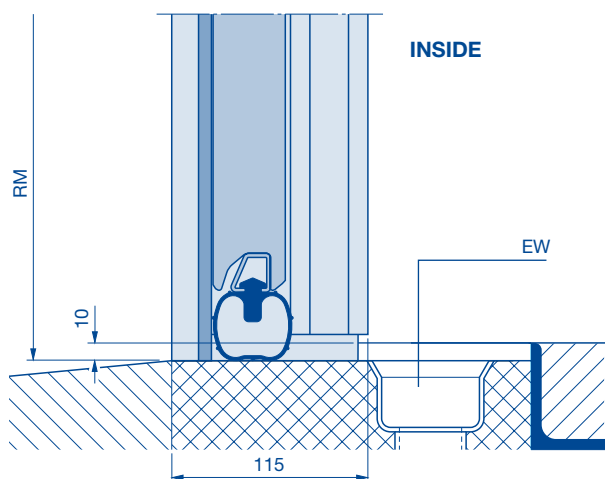
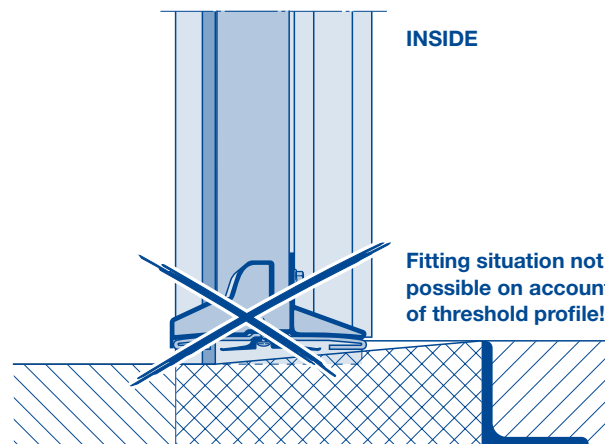
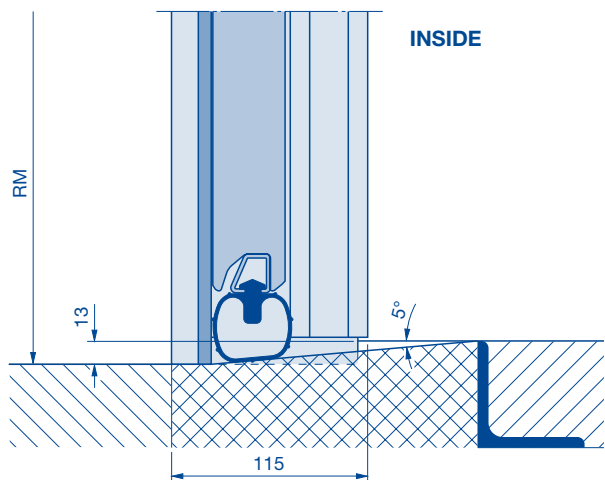

EW Drainage
RM Grid

Side Doors

With corner frame made of aluminium profiles

Standard / special sizes

External views

(The illustrations correspond to the size of the structural opening for 1000 x 2125 mm. Deviations may occur with other door sizes.)

* Side door version with styles (see page 18) only possible with profile type 1

Profile type 1 and 3



Profile type 2



Standard sizes

Profile type 1, only opening inwards, S, M, L-ribbed or S-panelled

Fitting: internal fitting

Profile type 3, S, M, L-ribbed or S-panelled

Fitting: external fitting

Ordering sizes = BRB	DRH from FFL	B
875 x 2000	955	500
875 x 2125	1010	531
1000 x 2000	955	500
1000 x 2125	1010	531

Profile type 2

S, M, L-ribbed

Fitting: internal or external fitting

Ordering sizes = BRB	DRH from FFL	B
875 x 2000	1050	500
875 x 2125	1050	531
1000 x 2000	1050	500
1000 x 2125	1050	531

Special sizes

Profile type 1 internal fitting profile type 3 external fitting, S, M, L-ribbed						
B	RM	A	BRB*	Min. BRH	Max. BRH	DRH
468	1875	4	550-1284	1800	1935	898
475	2375	4	550-1284	1800	1963	911
479	2875	4	550-1284	1800	1979	917
488	1955	4	550-1284	1800	2015	934
500	2000	4	550-1284	1800	2063	955
520	2080	4	550-1284	1800	2143	990
525	2625	4	550-1284	1800	2163	1000
531	2125	4	550-1284	1800	2187	1010
550	2205/2750	4	550-1284	1800	2263	1043
562	2250	4	550-1284	1804	2311	1064
468	1875	5	550-1284	1990	2403	898
475	2375	5	550-1284	2018	2438	911
479	2875	5	550-1284	2034	2458	917
488	1955	5	550-1284	2070	2500	934
500	2000	5	550-1284	2118	2500	955
520	2080	5	550-1284	2198	2500	990
525	2625	5	550-1284	2218	2500	1000
531	2125	5	550-1284	2242	2500	1010
550	2205/2750	5	550-1284	2318	2500	1043
562	2250	5	550-1284	2366	2500	1064

Profile type 2 internal or external fitting S, M, L-ribbed***						
B	RM	A	BRB*	Min. BRH**	Max. BRH	DRH
468	1875	4	550-1284	1800	1958	1050
475	2375	4	550-1284	1800	1986	1050
479	2875	4	550-1284	1800	2002	1050
488	1955	4	550-1284	1800	2038	1050
500	2000	4	550-1284	1800	2086	1050
520	2080	4	550-1284	1800	2166	1050
525	2625	4	550-1284	1800	2186	1050
531	2125	4	550-1284	1800	2210	1050
550	2205/2750	4	550-1284	1800	2286	1050
562	2250	4	550-1284	1804	2334	1050
468	1875	5	550-1284	1990	2426	1050
475	2375	5	550-1284	2018	2461	1050
479	2875	5	550-1284	2034	2481	1050
488	1955	5	550-1284	2070	2500	1050
500	2000	5	550-1284	2118	2500	1050
520	2080	5	550-1284	2198	2500	1050
525	2625	5	550-1284	2218	2500	1050
531	2125	5	550-1284	2242	2500	1050
550	2205/2750	5	550-1284	2318	2500	1050
562	2250	5	550-1284	2366	2500	1050

Profile type 1 internal fitting profile type 3 external fitting, S-panelled						
B	RM	A	BRB**	Min. BRH*	Max. BRH	DRH
468	1875	4	725-1284	1881	1935	898
475	2375	4	725-1284	1906	1963	911
479	2875	4	725-1284	1920	1979	917
488	1955	4	725-1284	1951	2015	934
500	2000	4	725-1284	1993	2063	955
520	2080	4	725-1284	2063	2143	990
525	2625	4	725-1284	2081	2163	1000
531	2125	4	725-1284	2102	2187	1010
550	2205/2750	4	725-1284	2168	2263	1043
562	2250	4	725-1284	2210	2311	1064
468	1875	5	725-1284	2349	2403	898
475	2375	5	725-1284	2381	2438	911
479	2875	5	725-1284	2399	2458	917
488	1955	5	725-1284	2439	-	934
500	2000	5	725-1284	2493	-	955

* Glazing type D: min BRB = 874 or panel glazing type M: min BRB = 857

** BRH < 1800 only with profile type 2 and DRH = BRH / 2 possible on request

*** 3-point locking from BRH > 1960 mm

A No. of door sections
B Door section height
BRB Nominal size width

BRH Nominal height
DRH Lever height
RM Grid height

Side Doors

With corner frame made of aluminium profiles

Standard / special sizes

Profile type 1
(only opening inwards)

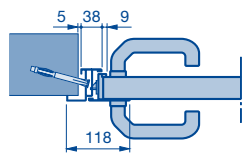

Profile type 2
(opening inwards)

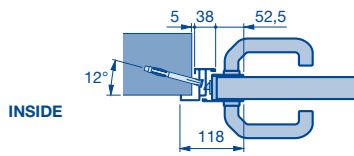

Profile type 2
(opening outwards)

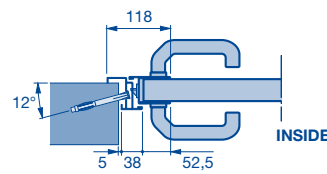

Profile type 3
(only opening outwards)

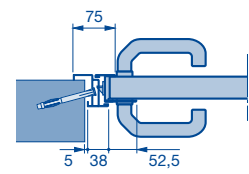

Internal fitting

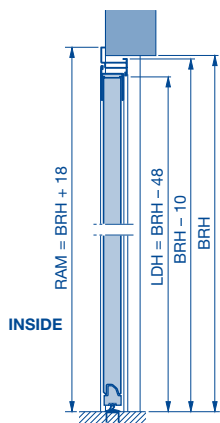

External fitting

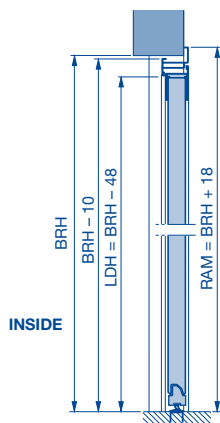

Internal fitting (opening inwards), profile type 1 or 2

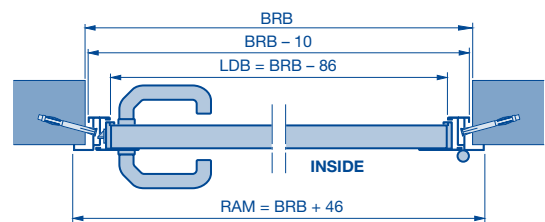
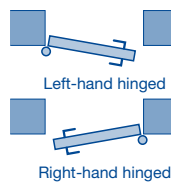

External fitting (opening outwards), profile type 2 or 3

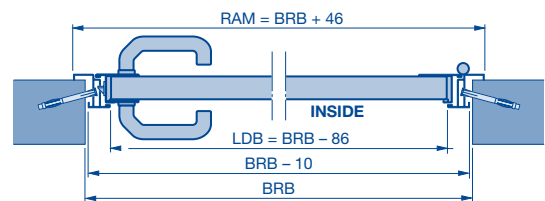
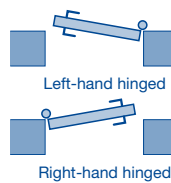

BRB Nominal size width
BRH Nominal height
LDB Clear passage width

LDH Clear passage height
RAM Overall frame dimension

Side Doors

With block frame made of aluminium profiles

Standard sizes

External views

(The illustrations correspond to the size of the structural opening for 1000 × 2125 mm. Deviations may occur with other door sizes.)

* Side door version with styles (see page 18) only possible with profile type 1

Profile type 1

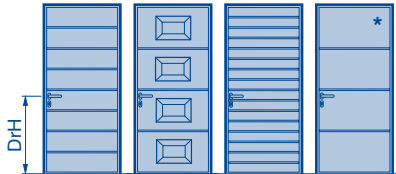

Profile type 2

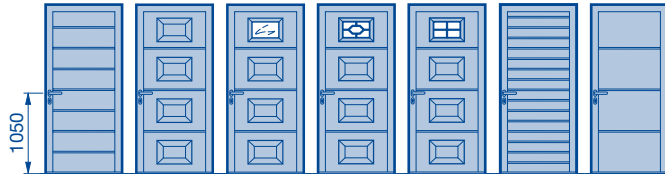

Standard sizes (profile type 1, only opening inwards)

Profile type 1 (fitting behind the opening) S, M, L-ribbed, S-panelled			
LF of the opening	Ordering sizes = RAM	DRH from FFL	B
855–875 × 1990–2000	990 × 2058	955	500
855–875 × 2115–2125	990 × 2183	1010	531
980–1000 × 1990–2000	1115 × 2058	955	500
980–1000 × 2115–2125	1115 × 2183	1010	531

Profile type 2 (fitting behind the opening) S, M, L-ribbed, S-panelled			
LF of the opening	Ordering sizes = RAM	DRH from FFL	B
855–875 × 1990–2000	990 × 2058	1050	500
855–875 × 2115–2125	990 × 2183	1050	531
980–1000 × 1990–2000	1115 × 2058	1050	500
980–1000 × 2115–2125	1115 × 2183	1050	531

Profile type 2 (fitting in the opening) S, M, L-ribbed			
LF of the opening	Ordering sizes = RAM	DRH from FFL	B
875 × 2000	855 × 1990	1050	500
875 × 2125	855 × 2115	1050	531
1000 × 2000	980 × 1990	1050	500
1000 × 2125	980 × 2115	1050	531

Note with glazing type D: Min. RAM width 980 mm and min. RAM height 2115 mm for glazing on the upper door section.

(See next page for the legend)

B Door section height
DRH Lever height
LF Structural opening
RAM Overall frame dimension

Side Doors

With block frame made of aluminium profiles

Standard sizes

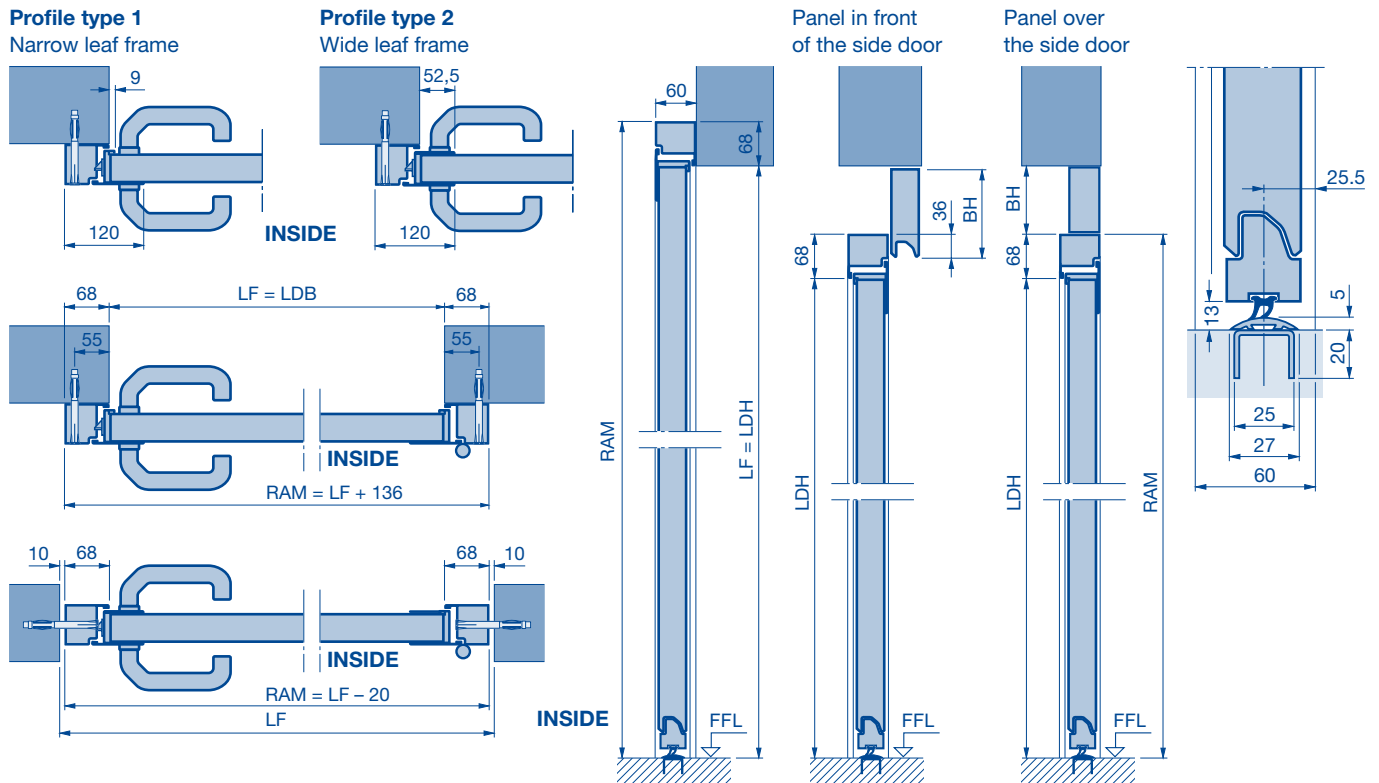

Fitting arrangements



Fitting next to the door, opening outwards, RH hinged

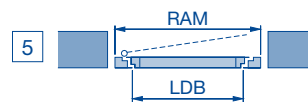

Fitting in the opening, opening outwards, RH or LH hinged

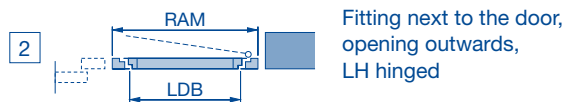

Fitting next to the door, opening outwards, LH hinged

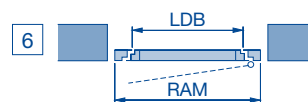

Fitting in the opening, opening inwards, RH or LH hinged

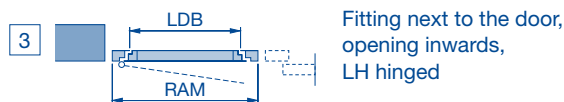

Fitting next to the door, opening inwards, LH hinged

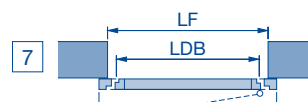

Fitting behind the opening, only opening inwards, RH or LH hinged

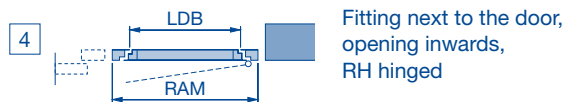

Fitting next to the door, opening inwards, RH hinged

INSIDE

BH Panel height
LDB Clear passage width
LDH Clear passage height
LF Structural opening

RAM Overall frame dimension

Side Doors

With block frame made of aluminium profiles

Special sizes

External views

(The illustrations correspond to the size of the structural opening for 1000 × 2125 mm. Deviations may occur with other door sizes.)

Profile type 2



Special sizes (profile type 1, only opening inwards)

Profile type 1 (fitting in or behind the opening), S, M, L-ribbed						
B	RM	A	RAMB*	Min. RAMH	Max. RAMH	DRH
468	1875	4	550-1330	1800	1955	898
475	2375	4	550-1330	1800	1983	911
479	2875	4	550-1330	1800	1999	917
488	1955	4	550-1330	1800	2035	934
500	2000	4	550-1330	1800	2083	955
520	2080	4	550-1330	1800	2163	990
525	2625	4	550-1330	1800	2183	1000
531	2125	4	550-1330	1800	2207	1010
550	2205/2750	4	550-1330	1800	2283	1043
562	2250	4	550-1330	1825	2331	1064
468	1875	5	550-1330	2011	2423	898
475	2375	5	550-1330	2039	2458	911
479	2875	5	550-1330	2055	2478	917
488	1955	5	550-1330	2091	2523	934
500	2000	5	550-1330	2139	2558	955
520	2080	5	550-1330	2219	2558	990
525	2625	5	550-1330	2239	2558	1000
531	2125	5	550-1330	2263	2558	1010
550	2205/2750	5	550-1330	2339	2558	1043
562	2250	5	550-1330	2387	2558	1064

Profile type 2 (fitting in or behind the opening), S, M, L-ribbed***						
B	RM	A	RAMB*	Min. RAMH**	Max. RAMH	DRH
468	1875	4	550-1330	1800	1979	1050
475	2375	4	550-1330	1800	2007	1050
479	2875	4	550-1330	1800	2023	1050
488	1955	4	550-1330	1800	2059	1050
500	2000	4	550-1330	1800	2107	1050
520	2080	4	550-1330	1800	2187	1050
525	2625	4	550-1330	1800	2207	1050
531	2125	4	550-1330	1800	2231	1050
550	2205/2750	4	550-1330	1800	2307	1050
562	2250	4	550-1330	1825	2355	1050
468	1875	5	550-1330	2011	2447	1050
475	2375	5	550-1330	2039	2482	1050
479	2875	5	550-1330	2055	2502	1050
488	1955	5	550-1330	2091	2547	1050
500	2000	5	550-1330	2139	2558	1050
520	2080	5	550-1330	2219	2558	1050
525	2625	5	550-1330	2239	2558	1050
531	2125	5	550-1330	2263	2558	1050
550	2205/2750	5	550-1330	2339	2558	1050
562	2250	5	550-1330	2387	2558	1050

Profile type 1 (fitting behind the opening), S-panelled						
B	RM	A	RAMB	Min. RAMH	Max. RAMH	DRH
468	1875	4	725-1330	1902	1955	898
475	2375	4	725-1330	1926	1983	911
479	2875	4	725-1330	1940	1999	917
488	1955	4	725-1330	1972	2035	934
500	2000	4	725-1330	2014	2083	955
520	2080	4	725-1330	2084	2163	990
525	2625	4	725-1330	2101	2183	1000
531	2125	4	725-1330	2122	2207	1010
550	2205/2750	4	725-1330	2189	2283	1043
562	2250	4	725-1330	2231	2331	1064
468	1875	5	725-1330	2370	2423	898
475	2375	5	725-1330	2401	2458	911
479	2875	5	725-1330	2419	2478	917
488	1955	5	725-1330	2460	2523	934
500	2000	5	725-1330	2514	-	955

Profile type 2 (fitting behind the opening), S-panelled						
B	RM	A	RAMB	Min. RAMH	Max. RAMH	DRH
468	1875	4	725-1330	1944	1979	1050
475	2375	4	725-1330	1968	2007	1050
479	2875	4	725-1330	1982	2023	1050
488	1955	4	725-1330	2014	2059	1050
500	2000	4	725-1330	2056	2107	1050
520	2080	4	725-1330	2126	2187	1050
525	2625	4	725-1330	2143	2207	1050
531	2125	4	725-1330	2164	2231	1050
550	2205/2750	4	725-1330	2231	2307	1050
562	2250	4	725-1330	2273	2355	1050
468	1875	5	725-1330	2412	2447	1050
475	2375	5	725-1330	2443	2482	1050
479	2875	5	725-1330	2461	2502	1050
488	1955	5	725-1330	2502	2547	1050
500	2000	5	725-1330	2556	-	1050

* Glazing type D: min RAMB = 923 or panel glazing type M: min RAMB = 905

** RAMH < 1800 only with profile type 2 and DRH = RAMH / 2 possible on request

*** 3-point locking from RAMH > 1960 mm

A No. of door sections
B Door section height
DRH Lever height
RAMB Overall frame dimension width

RAMH Overall frame height
RM Grid height

Side Doors

With block frame made of aluminium profiles

Special sizes

Fitting next to the door, opening outwards, RH or LH hinged

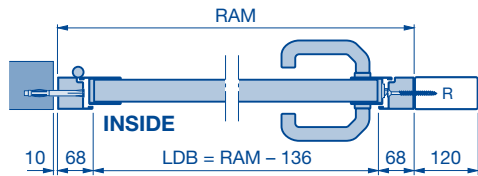

Fitting next to the door, opening inwards, RH or LH hinged

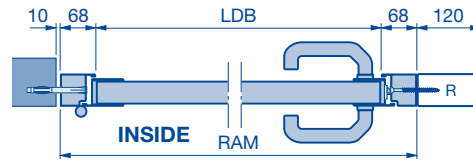

Fitting in the opening, opening inwards or outwards, RH or LH hinged

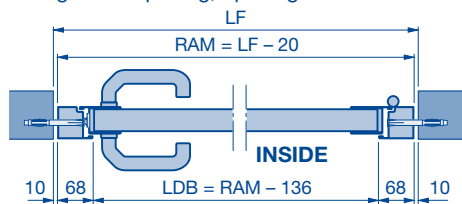

Fitting behind the opening, opening inwards, RH or LH hinged

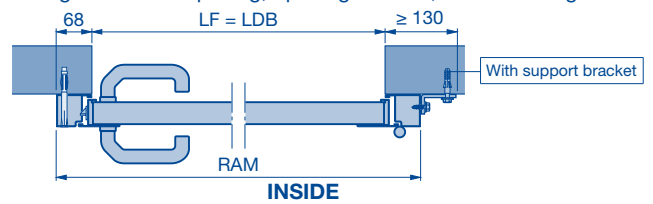

Fitting behind the opening

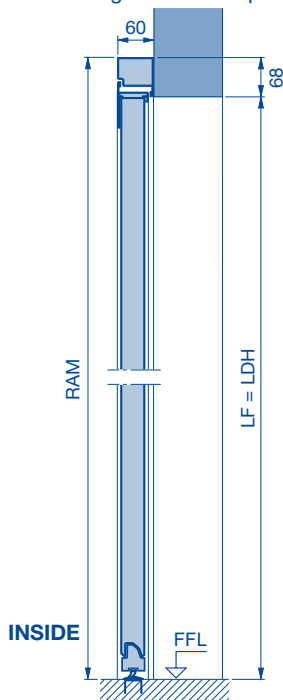

Fitting in the opening

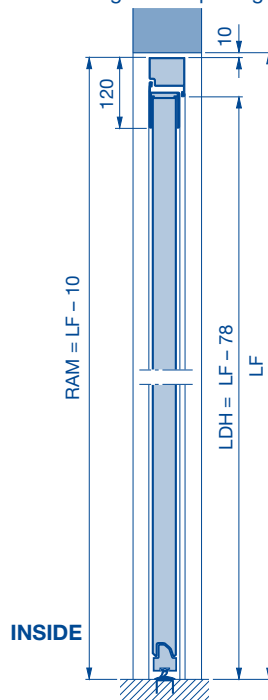

- DRH** Lever height
- LDB** Clear passage width
- LDH** Clear passage height
- LF** Structural opening

- R** Box section
- RAM** Overall frame dimension

Side Doors

Double-leaf side doors with block frames made of aluminium profiles

Fitting in the opening, profile type 2

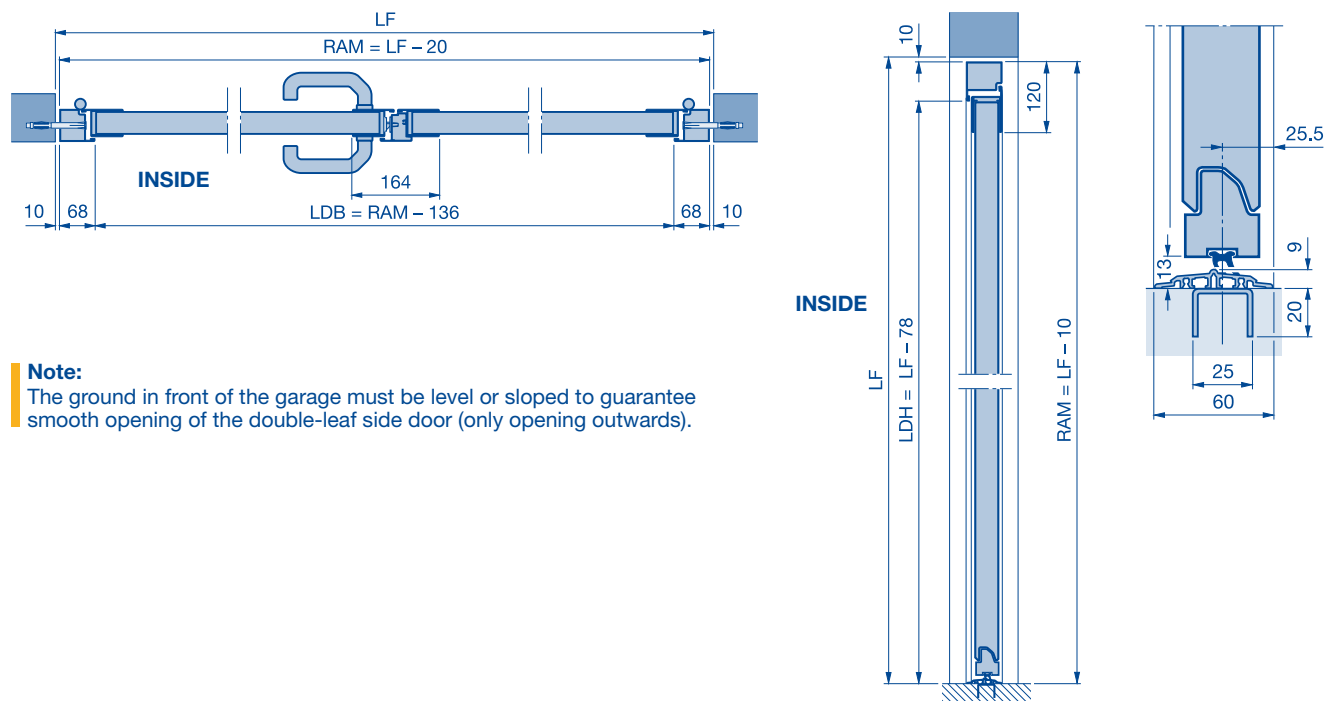

Note:

The ground in front of the garage must be level or sloped to guarantee smooth opening of the double-leaf side door (only opening outwards).

Fitting arrangements

Fitting in the opening, opening outwards, right-hand hinged

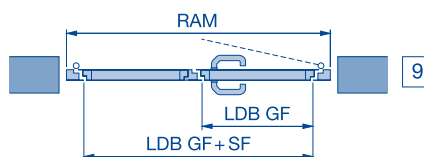
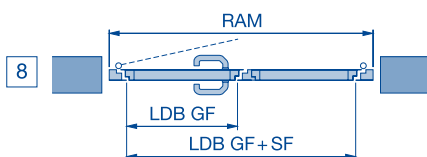

Fitting in the opening, opening outwards, left-hand hinged

Special sizes

Profile type 2 (fitting in the opening), S, M, L-ribbed***						
B	RM	A	RAMB	Min. RAMH	Max. RAMH	DRH
468	1875	4	1200-2500	1960	1979	1050
475	2375	4	1200-2500	1960	2007	1050
479	2875	4	1200-2500	1960	2023	1050
488	1955	4	1200-2500	1960	2059	1050
500	2000	4	1200-2500	1960	2107	1050
520	2080	4	1200-2500	1960	2187	1050
525	2625	4	1200-2500	1960	2207	1050
531	2125	4	1200-2500	1960	2231	1050
550	2205/2750	4	1200-2500	1960	2307	1050
562	2250	4	1200-2500	1960	2355	1050
468	1875	5	1200-2500	2011	2447	1050
475	2375	5	1200-2500	2039	2482	1050
479	2875	5	1200-2500	2055	2502	1050
488	1955	5	1200-2500	2091	2547	1050
500	2000	5	1200-2500	2139	2558	1050
520	2080	5	1200-2500	2219	2558	1050
525	2625	5	1200-2500	2239	2558	1050
531	2125	5	1200-2500	2263	2558	1050
550	2205/2750	5	1200-2500	2339	2558	1050
562	2250	5	1200-2500	2387	2558	1050

A No. of door sections
B Door section height
DRH Lever height
LF Structural opening

LDB Clear passage width
GF Traffic leaf
SF Fixed leaf
LDH Clear passage height

RAM Overall frame dimension
RAMB Overall frame dimension width
RAMH Overall frame height
RM Grid height

Timber Side Doors

Standard / special sizes

External views

(The illustrations correspond to the size of the structural opening for 1000 x 2125 mm. Deviations may occur with other door sizes.)

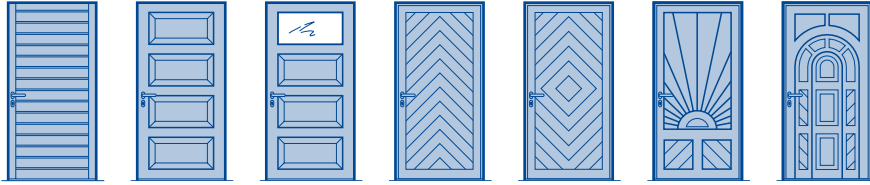

S-ribbed or V-panelled version			
Structural opening	Ordering sizes = RAM	Lever handle height from FFL	Spacing
Standard sizes			
855 – 875 x 2115 – 2125	1005 – 2190	1050	133
980 – 1000 x 2115 – 2125	1130 – 2190	1050	133
Special sizes			
990 – 1250 x 1940 – 2315		1050	

Style version		
Structural opening	Ordering sizes = RAM	Lever handle height from FFL
Standard sizes		
980 – 1000 x 2115 – 2125	1130 – 2190	1050
Special sizes		
1130 – 1250 x 1940 – 2315		1050

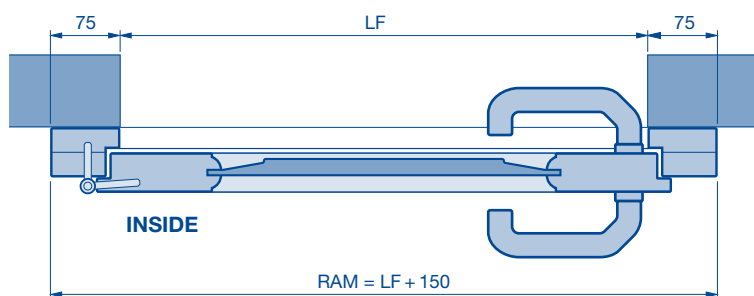
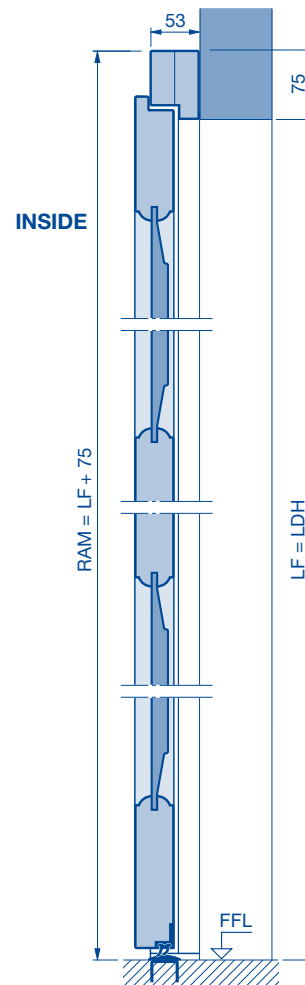

LF Structural opening
 LDH Clear passage height
 RAM Overall frame dimensions